

RadMote: A Mobile Framework for Radiation Monitoring in Nuclear Power Plants

Javier Barbarán, Manuel Díaz, Iñaki Esteve, and Bartolomé Rubio

Abstract—Wireless Sensor Networks (WSNs) have attracted the attention of many researchers. This has resulted in their rapid integration in very different areas such as precision agriculture, environmental monitoring, object and event detection and military surveillance. Due to the current WSN characteristics this technology is specifically useful in industrial areas where security, reliability and autonomy are basic, such as nuclear power plants, chemical plants, and others. In this paper we present a system based on WSNs to monitor environmental conditions around and inside a nuclear power plant, specifically, radiation levels. Sensor nodes, equipped with radiation sensors, are deployed in fixed positions throughout the plant. In addition, plant staff are also equipped with mobile devices with higher capabilities than sensors such as for example PDAs able to monitor radiation levels and other conditions around them. The system enables communication between PDAs, which form a Mobile Ad-hoc Wireless Network (MANET), and allows workers to monitor remote conditions in the plant. It is particularly useful during stoppage periods for inspection or in the event of an accident to prevent risk situations.

Keywords—MANETs, Mobile computing, Radiation monitoring, Wireless Sensor Networks.

I. INTRODUCTION

NOWADAYS we absolutely depend on energy. Nuclear energy is the source that generates more energy in comparison with others 'dirty energies' such as thermal energy and regrettably much more than the so called 'clean energies'. For this reason, nuclear power plants are present in a lot of countries, but their correct and safe operation is essential for the population. Due to the extremely serious repercussions that a nuclear accident could provoke, safety measures are especially important in this kind of power plant. Therefore, the legislation on nuclear power plants in countries throughout the world is very strict in safety measures. New systems must be researched and developed in order to improve, extend and update security and prevention systems.

Wireless Sensor Networks (WSNs) are a new form of distributed computing where sensors (tiny, low-cost and low-power nodes, colloquially referred to as "motes") deployed in the environment communicate wirelessly to gather and report information about physical phenomena [1]. These tiny sensor nodes, which incorporate sensing, data processing, and communicating components, leverage the idea of sensor networks. In the last few years, considerable advances in the field of WSNs has resulted in the development of several applications

in academia. Some of these have been successfully integrated in industrial applications, such as environmental monitoring, object and event detection, military surveillance and precision agriculture [2].

On the other hand, *Mobile "Ad-hoc" wireless NETWORKS* (MANETs) constitute a well-known paradigm of networks composed of a collection of autonomous nodes that do not rely on a predefined and fixed architecture. Nodes of such a network are often mobile, communicating with each other through wireless links and maintaining connectivity in a decentralized manner: each node operates as both a host and a router, and network connectivity and control is reached through the cooperation of every node. The network topology is, in general, dynamic because nodes frequently enter and leave the radio coverage area of other nodes [3].

The combination of these two technologies is providing powerful, mobile, versatile and dynamic applications. Much work has targeted the development of applications and prototypes for the detection and tracking of radiation sources focussing on security issues, particularly in order to prevent terrorist attacks or illicit transport of radioactive sources [4]-[6]. However, to the best of our knowledge, less work proposes a system for monitoring environmental conditions inside nuclear power plants in order to improve safety measures. Nowadays, all nuclear plant personnel are equipped with personal dosimeters, constantly checking the radiation level in the zone where they are moving as a safety measure. Nevertheless, sometimes workers need more information, for example in stoppage periods during periodic inspections or even in the event of an accident when personnel need to be informed in real-time not only about the measurements taken by their dosimeters but also from radiation measurements in the vicinity.

This paper presents a system for mobile monitoring of radiation measurement in a nuclear power plant. The proposed system is based on the joint use of WSNs and MANETs. Our reference operational setting is based on an architecture where there is a dense deployment of stationary sensors with radiation measurement capabilities throughout a nuclear power plant, not only inside but also outside the plant. Additionally, there are mobile devices, *Personal Digital Assistant* (PDAs), with a radiation measurement device connected that are carried by plant staff. This way, each PDA searches for reachable WSNs, gets wireless connection, gathers and shows proximity conditions so that each worker is informed about them in real-time. All the PDAs involved in the system are connected through a wireless connection constituting a MANET. Thus, plant staff are able to monitor data from surrounding regions through other PDAs.

This work is supported by the EU funded project FP6 IST-5-033563 and the Spanish project TIN2005-09405-C02-01.

J. Barbarán, M. Díaz, I. Esteve and B. Rubio are with the Department of Languages and Computer Science, Málaga University, 29071, Spain.

J. Barbarán is the corresponding author to provide phone: +34 952 137147; fax: +34 952 131397. Authors e-mail: {barbaran, mdr, esteve, tolo}@lcc.uma.es.

The rest of this paper is structured as follows. In section II the operational setting is detailed. Section III describes the architecture proposed for this kind of system. Some implementation details of the current system prototype are presented in Section IV and finally, some conclusions and future work are sketched in Section V.

II. OPERATIONAL SETTING

The proposed system, as mentioned in section I, is focussed on environmental monitoring of nuclear power plants where sensors are deployed in fixed positions, equipped with radiation measurement devices, inside and also outside the plant. Sensors have a unique identifier in the network. Multi-hop communication [7] is used between sensors which collaborate with each other in order to send measurements to some "sink" sensor nodes which retransmit data gathered to higher capability devices in order to display it. These devices are PDAs, which will be connected through WiFi links in an ad-hoc manner forming a MANET where different nodes can share the measurements (Fig. 1). Thus, plant personnel will also be able to monitor conditions in far regions in the plant. In distributed mobile applications such as the system we propose, where nodes can disappear and appear, the client/server architecture is not appropriate because if a server failed or disappeared, this would lead to a whole system failure. Using a *peer-to-peer* (p2p) architecture this outcome would be avoided.

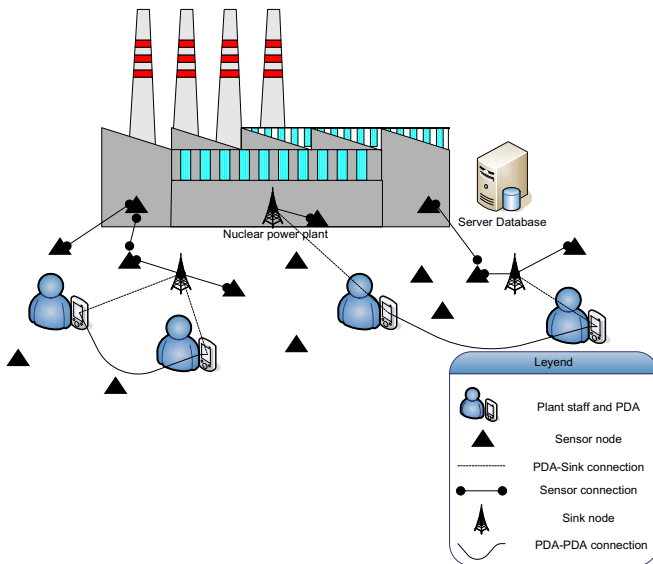

Fig. 1. Operational setting

The proposed scenario will offer some advantages and must provide some basic functionalities. The most important functionality required is that each worker must be informed of the radiation measurements near him/her via a PDA and must also receive information collected from not accessible WSNs through the MANET formed by PDAs. Additionally, in the system a central server equipped with a database is proposed in order to store measurements for further analysis.

The measurements are sent to sink nodes and to the central server.

Another interesting functionality related to WSN characteristics must be taken into account. Nowadays, different providers of hardware implementations exist on the market and most of them are not compatible with each other or it is difficult to intercommunicate them. According to current research and Moore's law, chips will still become smaller and memory capabilities will increase. Therefore, WSN technology will be in continuous progress, so our system must be prepared for hardware updates with minimal changes. For these reasons, in the proposed scenario, the possibility of using different kinds of WSNs at the same time or substituting one kind of sensor for another are considered.

Basic features of the system sketched are the following:

- Displaying data in PDAs in real-time from environmental conditions.
- Displaying the relative position of sensor nodes. Because sensors are deployed in fixed positions a file might be created indicating the positions of each sensor node. Another way is to use localization algorithms.
- Alarm generation and propagation. Sensor nodes will be programmed to detect risk situations where radiation measurements exceed a threshold and send this information to sink nodes and this information will be shown on the PDA display.
- Interaction with central server in order to send it the information collected or displaying data on the PDA from the database.

III. SYSTEM ARCHITECTURE

The proposed architecture of RadMote and its main characteristics are detailed in this section. Figure 2 shows the different layers forming the middleware installed on PDAs. Each layer has a different set of components, which are described in the following subsections.

A. Communication layer

The lowest layer is in charge of implementing communication primitives and accessing physical devices, directly to WSNs and PDAs. As mentioned in section II, nowadays different kinds of WSN exist. The main problem is that most WSNs are not able to interoperate with each other or at least it is difficult to make them work together and sometimes additional hardware is necessary. Indeed, different types of sensors are composed of different hardware components, embedded software and even different standards for communicating such as Bluetooth technology and 802.15.4/ZigBee protocols in bnodes [8] and micaz motes provided by Crossbow Inc [9] respectively. In addition, WSN technology is under continuous development and new sensor types are emerging as result of academia and enterprise research efforts. The new motes Imote2 for example have recently been developed by Crossbow Inc. Consequently, we propose an extensible architecture where new components can be added in order to deal with new sensor nodes. Therefore, for each different sensor device, a specific communication component must exist in this layer.

On the other hand, a component also exists that is in charge of implementing communication between PDAs. In section II, we mentioned that the p2p architecture seems to be the most appropriate for MANETs so we have defined the component *Communication PDA* where the p2p system is integrated. This component is flexible and can be changed for specific existing or future middleware. Some examples of existing embedded middleware for p2p environments are JMobiPeer [10] and JXTA [11]. At the moment our research group is collaborating with the SMEPP project [12], a recently initiated EU funded project, where a secure middleware for embedded p2p systems is under development.

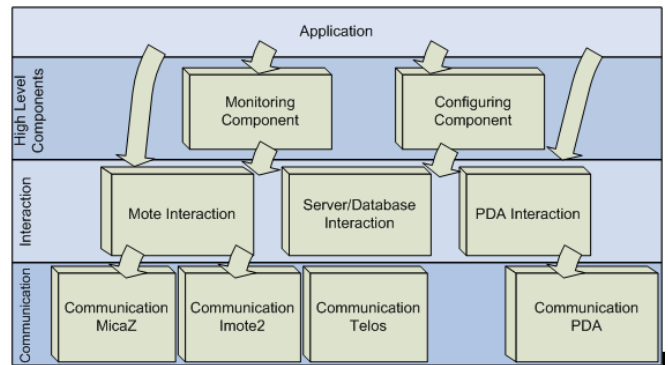

Fig. 2. Proposed Architecture.

B. Interaction layer

The next layer is the bridge between the communication layer and the high level and application layers. It provides transparency and new functionality to the higher layers. Three components are mainly provided by this layer: *Mote Interaction*, *Server/Database Interaction* and *PDA Interaction*. The *Mote Interaction* component transmits all the requests directed to motes and processes all the information received, forwarding data collected from the WSN properly formatted. It also provides an interface for higher layers to simplify mote interaction. Although the RadMote system proposes the measurement of radiation conditions in a nuclear power plant, it might be useful to measure other conditions in the plant. For this reason, one problem we have to approach is that in most commercial WSNs there exist different sensor boards with different types of sensors for measuring different conditions. This way, in a WSN where motes have different types of sensor boards, the mote programming defines different types of messages in order to differentiate sensor boards attached to each mote when receiving data from the WSN. Therefore, those messages received, in the Communication layer, will depend on the mote that sends the information and will also depend on the sensor board that it has attached. Therefore, to homogenize received messages, the *Mote Interaction* component defines a special packet with a generic definition. This way, higher layers do not have to deal with different kinds of messages and can send information to sensors transparently.

As said above, the *Communication PDA* component can be interchanged with different p2p middleware. The component *PDA Interaction* is a special component that wraps the specific p2p middleware interfaces using an interface fixed to a higher layer. This way, if the *Communication PDA* component is interchanged, it does not affect the high level and application layers.

The *Server/Database Interaction* component is used to send information gathered from the WSN to a central server. This information can be sent through the MANET or using a wireless Internet connection. It is not the purpose of this article to describe the behavior of the server, but it must deal with duplicate data received from different PDAs and must deal with the replication of servers in order to prevent possible off-line periods due to server failures.

C. High level layer

Two components are present in this layer, the *Configuration component* and the *Monitoring component*. These components allow application programmers to easily perform complex actions such as monitoring and configuration of WSNs, and MANETs.

The *Monitoring component* provides primitives for monitoring WSN issues. Specifically, it provides primitives to get network topology. Additionally, using a location file, this component provides primitives which are useful to the application programmer in order to draw the relative positions of the different motes. This component also interacts with the *PDA Interaction* component in order to implement primitives that give the current direct connections between the PDA where the system is deployed and other remote PDAs.

The Configuration component helps the application programmer in tasks of reconfiguring network aspects. This component is particularly useful for reconfiguring WSN options, such as sleeping periods in motes or sensing intervals. In addition, depending on how reconfigurable the middleware is for the p2p system installed on the component 'PDA Communication', different primitives might be added to this component.

IV. IMPLEMENTATION ISSUES

In order to evaluate the architecture proposed, we have developed a prototype of RadMote. To develop this prototype, the following hardware devices have been used (Figure 3):

- A sensor mote consisting of a MICAz processor and radio platform together with a sensor board, both from Crossbow technologies. The MICAz has an 8 MHz Atmel ATmega128L 8-bit microprocessor connected to a 2.4 GHz Chipcon CC2420 (IEEE 802.15.4/Zigbee compliant) radio transceiver. The radio communicates at up to 250 Kbps. The platform has a flash memory with 128 Kb for program and 512 Kb for user data. MICAz motes run TinyOS [13], a simple but highly concurrent open source operating system, which has been implemented using nesC [14], a C-based programming language for networked embedded systems, such as sensor networks.
- The system proposed is based on radiation measurements, but there are no radiation sensors in the market designed



Fig. 3. Devices used in the prototype

to be connected to sensor nodes. Currently, a partner company, Tecnatom [15], that has considerable experience in the nuclear energy business, is developing a radiation sensor capable of connecting to MICAz motes. To connect the new sensor that is currently being manufactured we are going to use the Crossbow MDA100CA or MDA300CA sensor board equipped with a general prototyping area for connecting new sensors. The prototyping area supports connection to all 51 pins on the expansion connector, and provides an additional 42 unconnected solder points for breadboarding. For this reason, this first prototype has been developed using other kinds of sensor boards that simulate radiation measurements. For this prototype we have used the MTS300 sensor board, which has a variety of sensing modalities. These modalities include light, temperature, acoustic and sounder. In some experiments we have also used the MTS310 sensor board which has two other sensing modalities: 2-Axis accelerometer and 2-Axis magnetometer.

- Due to the incompatibility of communication standards between PDAs and sensor motes, a Stargate gateway is used as the sink nodes to interconnect Crossbow family motes using 802.15.4/Zigbee compliant standard and PDAs using Wi-Fi (802.11.b) standard. The Stargate is a powerful single board computer with enhanced communications and sensor signal processing. The Stargate uses an Intel's latest generation 400 MHz XScale processor (PXA255). This product was designed within the Intel's Ubiquitous Computing Research Program. It also directly supports applications around TinyOS based on WSNs. Stargate development is shipped with a preinstalled embedded Linux operating system kernel. This device has higher memory, processor capabilities and connectivity (PCMCIA, USB, ethernet, serial connector) capabilities than sensors and other gateways.
- The PDA HP iPAQ hw6500 Mobile Messenger have been used as mobile devices. They have GSM connectivity, wireless and bluetooth connection capabilities, GPS receptor integrated and a camera that enables users to take and send photos.

The .NET Compact Framework 2.0 [16] is the programming framework used to implement the middleware architecture components inside the PDAs. The programming language C

has been used for programming the Stargate. nesC is the language used to program sensor nodes.

Figure 4 shows the prototype layout where sensor nodes are deployed in fixed positions. Environmental sensed data flows through the network to the sink nodes (Stargate gateways). PDAs get connected to any of the reachable gateways in order to subscribe to the service of receiving gathered data. PDAs are also connected with each other in an ad-hoc manner. This way, if a PDA is far from the WSN, it can ask for WSN conditions from its PDA neighbors.

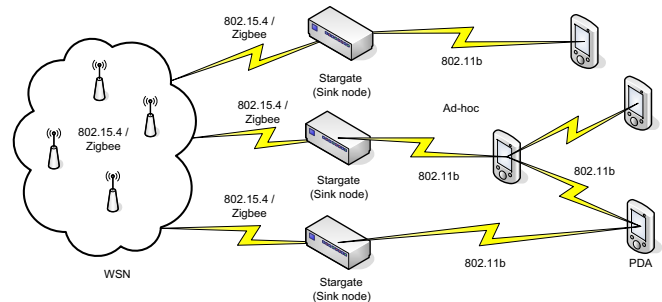

Fig. 4. Prototype layout

Figure 5 depicts a PDA screenshot where the gathered data from the WSN is displayed in a datagrid component.

A. Mote-Stargate interaction

MICAz motes have been programmed with a mesh networking application called *Surge_Reliable*, provided by Crossbow technology. This application allows sensors to take measurements on temperature, light, acoustic, sounder, magnetometer and accelerometer. In the message network information is also sent such as parent address, sequence number, so on. These measurements are taken every second, but this can be configured by the user. The message type of this application is defined as follows:

```
typedef struct SurgeMsg {
    uint8_t type;
    uint16_t reading;
    uint16_t parentaddr;
    uint32_t seq_no;
    uint8_t light;
    uint8_t temp;
    uint8_t magx;
    uint8_t magy;
    uint8_t accelx;
    uint8_t accely;
}
```

This kind of message are sent through the network from sensor nodes to sink nodes. Afterwards, sink nodes retransmit this data to wireless clients connected to the sink nodes.

B. Stargate-PDA interaction

As stated before, the Stargate is used as a sink node in order to interconnect sensor nodes and PDAs. Therefore, the Stargate is programmed with an application called *SerialForwarder*. This application is provided by TinyOS, and it is available both

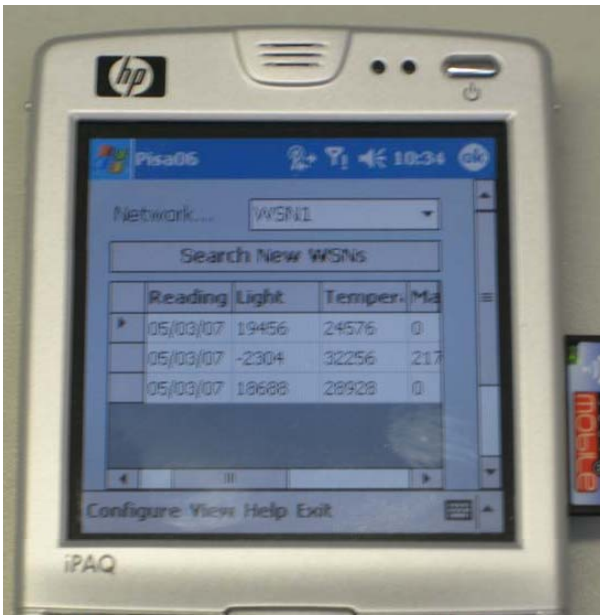

Fig. 5. Front-end application

as a Java application and as a C application. In the Stargate the C-based application is required. `SerialForwarder` is used to read/send packets from/to the serial port. The serial port is used by the Stargate to get in contact with the WSN.

This way, if a Stargate is reachable from a PDA, this will try to get connected to the Stargate. So, the *PDA Communication* layer must start a protocol to register to the `SerialForwarder` application installed on Stargate. Once PDA has been registered, the Stargate will retransmit gathered data to it.

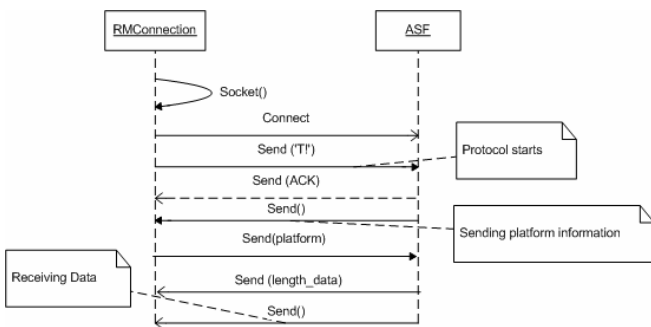

Fig. 6. SerialForwarder connection protocol

The protocol that must be implemented is shown in figure 6. So, any application that has to get connected to the Stargate through the `SerialForwarder` application, must open a BSD socket to the IP address of Stargate. Afterwards, the client application sends the sequence 'T!' that initiates the gossip with `SerialForwarder` and answers with an ack signal. Finally, both devices send sensor platform information. At this moment the communication is established, and clients of `SerialForwarder` act passively receiving packets from WSN. The `SerialForwarder` sends firstly the size of the message and then the packet message follows.

C. PDA-PDA interaction

To achieve PDA interaction, we propose a routing algorithm based on classic flooding techniques. The algorithm proposed is composed of 3 phases: discovery, query and answer. In the discovery phase, the peers send connection messages to the other peers in the network. If a peer receives a connection message, it knows that the peer that sent the message is one of its neighbor and answers with an acknowledgement message (ack). Therefore, the peer that sends the connection message will receive ack messages from its neighbours so that it knows who they are. In the query phase, the devices ask their neighbours for the information about the WSN. They will send petitions to their neighbours and they will eventually receive this information when their neighbours answer to them. In the answer phase the peers will receive messages from other peers and if they are able to do so, they will answer the query.

The behaviour of the routing algorithm is as follows: When a peer arrives to the network, it starts the discovery phase. The discovery of peers in the network is performed through the use of connection/ack messages as has been explained above.

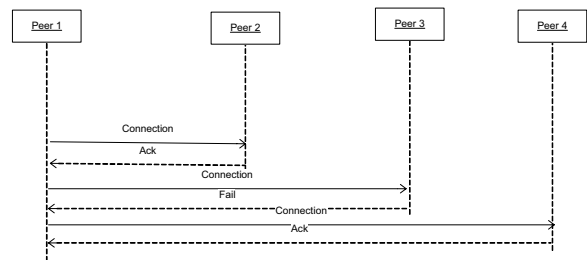

Fig. 7. Sequence diagram: Discovery phase

When this phase is completed, the peer knows the information about its neighbours. An example of the discovery phase can be seen in figure 7, where we can see the discovery phase of peer 1, given the topology of figure 8. The answer phase starts just after the discovery phase is completed and will last indefinitely, as long as the peer is alive. The main function of this phase is to receive connection and query messages and to answer to them.

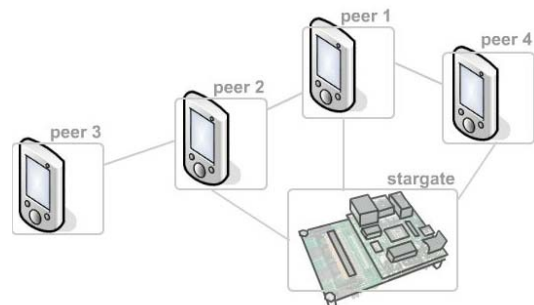

Fig. 8. Example of MANET topology

Another important issue about this phase is that it is executed concurrently with the query phase, so that both can

run at the same time. Just after starting the answer phase, the peer will try to receive the data sensed by the WSN from the stargate device. In the case where the data from the stargate is not available, the peer will start the query phase, in which it will ask its neighbours for this information. In the answer phase, the peer will receive the data sensed by the WSN from its neighbours, if this information is available for them. In figure 9, an example of how a peer obtains the information sensed by the sensor network from its neighbours is shown. This situation is based on the topology shown in figure 8. Note that as peer 3 cannot connect to the Stargate device, it will ask for this information its neighbour peer 2, which knows and provides this information.

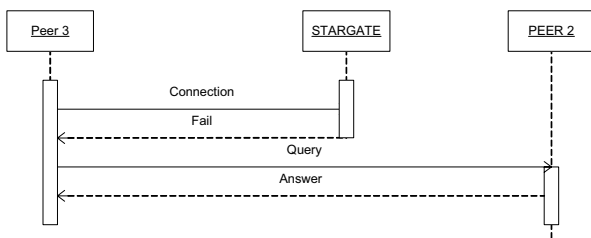

Fig. 9. Sequence diagram: Query and answer phases

Every time a connection fails from a peer to one of its neighbours, we will assume that there has been a change in the network topology, so the discovery phase will be repeated in order to get the correct information about the network topology. Moreover, if a peer receives a connection message from another peer that was previously not considered a neighbour, it will be added to the list of neighbours and an ack message will be sent to it. The three phases of our routing algorithm working together will let all the peers in the network receive the information sensed by the WSN in the current environment.

V. CONCLUSIONS AND FUTURE WORK

A system for monitoring radiation measurements in nuclear power plants, based on WSNs and MANETs, has been presented. This system will improve security in nuclear power plants by means of recent technologies. We have successfully concluded our first prototype but more needs to be done. In section IV we outlined the work that we are now undertaking to complete the system. We must integrate specific radiation sensors on the motes and we are currently working closely together with Tecnatom in order to develop new radiation sensors that work with MICAz nodes. Additionally, security features must be taken into account in future versions.

This work is being carried out in the context of the SMEPP project (Secure Middleware for Embedded Peer-to-Peer Systems), a recently initiated EU funded project (FP6 IST-5-033563), which has the general goal of developing a new secure, generic and highly customizable middleware, based on a new network centric abstract model for EP2P systems.

REFERENCES

- [1] I. F. Akyildiz, W. Su, Y. Sankarasubramaniam, E. Cayirci. "Wireless Sensor Networks: A Survey," *Computer Networks Journal*, 38(4):393-422,2002.
- [2] J. Gehrke, L. Liu (Eds). "Sensor-Networks Applications," *IEEE Internet Computing*, 10(2), 2006.
- [3] M. Bisignano, G. Di Modica, O. Tomarchio. "JMobiPeer: A middleware for mobile peer-to-peer computing in MANETS" *IEEE International Conference on Distributed Computing System Workshops*, 2005
- [4] R. Nemzek, J. Dreicer, D. Torney, T. Warnock. "Distributed Sensor Networks for Detection of Mobile Radioactive Sources," *IEEE Transactions on Nuclear Science*, pp 1693-1700, 2004.
- [5] S. Brennan, A. Mielke, D. Torney, A. MacCabe. "Radiation Detection with Distributed Sensor Networks," *Computer*, Vol. 37, Iss.8, pp 57-59, 2004.
- [6] S. Brennan, A. Mielke, D. Torney. "Radiation Source Detection by Sensor Networks," *IEEE Trans.*, pp 813-819, 2005.
- [7] "Multihop routing," http://www.tinyos.net/tinyos-1.x/doc/multihop/multihop_routing.html
- [8] "BTnodes" <http://www.btnode.ethz.ch/>
- [9] Crossbow Technology Inc. <http://www.xbow.com/>
- [10] M. Bisignano, G. Di Modica, O. Tomarchio "JMobiPeer: a middleware for mobile peer-to-peer computing in MANETS," *Distributed Computing Systems Workshops*, pp 785-791, 2005
- [11] "JXTA," <http://www.jxta.org>
- [12] "SMEPP project," <http://www.smepp.net>
- [13] "TinyOS," <http://www.tinyos.net>
- [14] D. Gay, P. Levis, R. von Behren, M. Welsh, E. Brewer, D. Culler "The nesC Language: A Holistic Approach to Networked Embedded Systems," *Proceedings of Programming Language Design and Implementation*, 2003
- [15] Tecnatom S.A. <http://www.tecnatom.es/>
- [16] E. M. Royer, Chai-Keong Toh. ".NET Compact Framework 2.0," <http://msdn.microsoft.com/mobility/netcf/> pp 46-55, 1999