

# Continuous and Discontinuous Shock Absorber Control through Skyhook Strategy in Semi-Active Suspension System (4DOF Model)

A. Shamsi, and N. Choupani

**Abstract**—Active vibration isolation systems are less commonly used than passive systems due to their associated cost and power requirements. In principle, semi-active isolation systems can deliver the versatility, adaptability and higher performance of fully active systems for a fraction of the power consumption. Various semi-active control algorithms have been suggested in the past. This paper studies the 4DOF model of semi-active suspension performance controlled by on-off and continuous skyhook damping control strategy. The frequency and transient responses of model are evaluated in terms of body acceleration, roll angle and tire deflection and are compared with that of a passive damper. The results show that the semi-active system controlled by skyhook strategy always provides better isolation than a conventional passively damped system except at tire natural frequencies.

**Keywords**—Semi-active suspension system, Skyhook, Vibration isolation, 4DOF model.

## I. INTRODUCTION

A passive suspension system is the simplest way to protect a vehicle from vibration inputs. There is a trade-off with this system, however, between the control of vibration at resonance, when a highly damped isolator is desirable, and the higher frequency isolation performance, when low damping is required. Active isolation systems can be used to overcome this limitation. They generally fall into two categories: semi-active and fully active. Fully active isolation systems apply dynamic forces at the same frequency as the primary excitation and can provide superior performance, but the system becomes more complex and there are a number of issues that need to be addressed. These include the selection of actuators and sensors, weight constraints, power requirements, stability, closed-loop performance and potential failure. Semi-active vibration isolation involves changing the system properties, such as damping and stiffness as a function of time [1].

In many Literatures has studied the performance of a semi-active dampers controlled with various methods. For example the LQR approach for vehicle suspension control is widely

used and is also used as a background for many studies [2].  $H_\infty$  and sliding mode control, adaptive control, fuzzy logic and neural network are other methods for semi-active suspension system control. Although complicated control strategies may offer some advantages, significant performance gains can still be realized with more basic control strategies. A widely known and widely used control scheme for controlling the vibration of the vehicle body is sky-hook damping presented by D. C. Karnopp et al. in 1974 [2]. The name "skyhook" is derived from the fact that it is a passive damper hooked to an imaginary inertial reference point [1]. The basis of the skyhook damping theory lies in the LQR approach [2].

Karnopp studied the performance of skyhook damping control [3], [4]. The reference models of semi-active suspension system are investigated by Goncalvez [5]. Semi-active dampers may be of the on-off type or of the continuously variable type [5]. The aim of this paper is to compare two basic control strategies in the vibration isolation. Continuous skyhook control [3], [6], [7] and on-off skyhook control [6], [8] are investigated and are compared with that of a passive damper.

Numerical simulations are carried out on a four degree of freedom (4DOF), roll-plane model, and results are presented to evaluate the suitability of these basic algorithms. The system performance is evaluated in terms of body acceleration, roll angle and tire deflection by frequency and transient analysis.

## II. MODEL FORMULATION

The model considered in this paper is a planar model with four degrees of freedom that represent the heave and roll of the vehicle body, as well as the wheel hop of the left and right tires.

This model which is showed in Fig. 1 consists of three masses. The top mass,  $m_b$ , represents the vehicle body, whereas the two lower masses,  $m_{t,l}$  and  $m_{t,r}$ , represent the left and right tires, respectively. The parallel spring and damper combinations located between the vehicle body and each tire ( $k_{s,l}$ ,  $c_{s,l}$  and  $k_{s,r}$ ,  $c_{s,r}$ ) represent the stiffness and damping of the vehicle suspension system. The respective stiffness' of the left and right tires are represented by the lower springs  $k_{t,l}$  and  $k_{t,r}$ .  $z_b$  and  $\theta_b$  represent the heave and roll motions of the vehicle body;  $z_{t,l}$  and  $z_{t,r}$  represent the heave motions of the left and

Ali Shamsi, M.S. Student, is with Department of Mechanical Engineering, Sahand University of Technology, P.O. Box 51335-1996, Tabriz, Iran (phone: +98-917-791-8736; e-mail: A\_Shamsi@sut.ac.ir).

Naghдали Choupani, Assistant Professor, is with Department of Mechanical Engineering, Sahand University of Technology, P.O. Box 51335-1996, Tabriz, Iran (phone:+98-914-406-6970; e-mail: Choupani@sut.ac.ir).

right vehicle tires;  $z_{in,l}$  and  $z_{in,r}$  represent the road inputs into the left and right tires of the model.

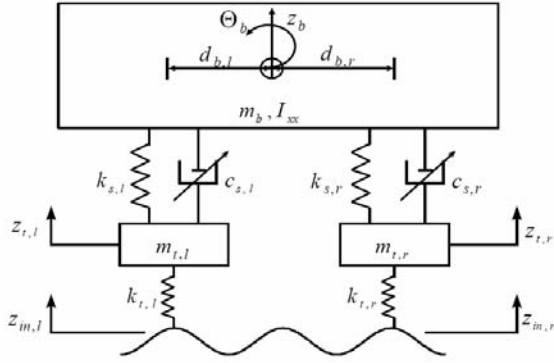

Fig. 1 Roll plane vehicle - model

The dynamics of the model in Fig. 1 are described by:

$$M \ddot{\bar{z}} + C \dot{\bar{z}} + K \bar{z} = f \quad (1)$$

Where  $M$ ,  $C$  and  $K$  represent the mass, damping and stiffness matrices, and  $f$  is force vector, described by:

$$M = \text{diagonal}[m_b, m_{t,l}, m_{t,r}, I_{xx}]$$

$$C = \begin{bmatrix} (c_{s,l} + c_{s,r}) & -c_{s,l} & -c_{s,r} & (-c_{s,l}d_{b,l} + c_{s,r}d_{b,r}) \\ -c_{s,l} & c_{s,l} & 0 & c_{s,l}d_{b,l} \\ -c_{s,r} & 0 & c_{s,r} & -c_{s,r}d_{b,r} \\ (-c_{s,l}d_{b,l} + c_{s,r}d_{b,r}) & c_{s,l}d_{b,l} & -c_{s,r}d_{b,r} & (c_{s,l}d_{b,l}^2 + c_{s,r}d_{b,r}^2) \end{bmatrix}$$

$$K = \begin{bmatrix} (k_{s,l} + k_{s,r}) & -k_{s,l} & -k_{s,r} & (-k_{s,l}d_{b,l} + k_{s,r}d_{b,r}) \\ -k_{s,l} & k_{s,l} & 0 & k_{s,l}d_{b,l} \\ -k_{s,r} & 0 & k_{s,r} & -k_{s,r}d_{b,r} \\ (-k_{s,l}d_{b,l} + k_{s,r}d_{b,r}) & k_{s,l}d_{b,l} & -k_{s,r}d_{b,r} & (k_{s,l}d_{b,l}^2 + k_{s,r}d_{b,r}^2) \end{bmatrix}$$

$$f = \begin{bmatrix} 0 \\ k_{t,l}z_{in,l} \\ k_{t,r}z_{in,r} \\ 0 \end{bmatrix}$$

### III. DESCRIPTION OF THE CONTROL STRATEGIES

Semi-active dampers may be of the on-off type or of the continuously variable type. A damper of the first type is switched between only two states "on" and "off". In its on state, the damping coefficient is relatively high, and in its off state, it is relatively low. Ideally the off-state damping should be zero, but in practical situations this is not possible. A continuously variable semi-active damper is also switched between on and off states and the values between them. The concepts of semi-active damping are illustrated in Fig. 2, which shows the force-velocity characteristics for an on-off

and a continuously variable damper. The shaded part of the graph in Fig. 2(b) represents the range of achievable damping coefficients for a continuously variable damper.

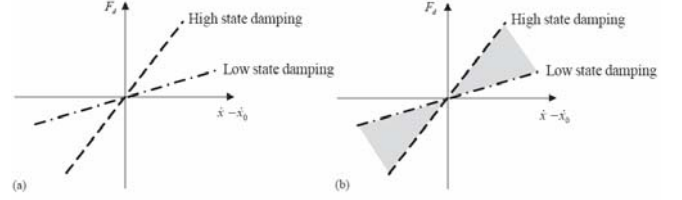

Fig. 2 Semi-active damper concepts

(a) on-off damper (b) Continuously variable damper [1]

This section describes two semi-active control strategies which are on-off and continuously variable implementations of skyhook control.

#### A. On-Off Skyhook Control

In on-off skyhook control, the damper is controlled by two damping values. The determination of whether the damper is to be adjusted to either its high state or its low state depends on the product of the relative velocity across the suspension damper and the absolute velocity of the vehicle body mass attached to that damper. If this product is greater than or equal to zero, the damper is adjusted to its high state. If this product is negative, then the low state of the damper is applied [1], [6]. For the roll-plane model of Fig. 1, the relative velocity across each of the suspension dampers is computed as:

$$\begin{aligned} v_{rel,l} &= \dot{z}_b - \dot{z}_{t,l} - d_{b,l}\dot{\theta}_b \\ v_{rel,r} &= \dot{z}_b - \dot{z}_{t,r} + d_{b,r}\dot{\theta}_b \end{aligned} \quad (2)$$

The absolute velocity of the vehicle body mass attached to the left and right side of each damper is thus calculated as:

$$\begin{aligned} v_{abs,l} &= \dot{z}_b - d_{b,l}\dot{\theta}_b \\ v_{abs,r} &= \dot{z}_b + d_{b,r}\dot{\theta}_b \end{aligned} \quad (3)$$

Therefore, the on-off skyhook control policy as it applies to the roll-plane model of Fig. 1 can be formulated by:

#### Left Damper:

$$\begin{aligned} v_{abs,l} \times v_{rel,l} &\geq 0 & c_{s,l} &= c_{max} \\ v_{abs,l} \times v_{rel,l} &< 0 & c_{s,l} &= c_{min} \end{aligned} \quad (4-a)$$

#### Right Damper:

$$\begin{aligned} v_{abs,r} \times v_{rel,r} &\geq 0 & c_{s,r} &= c_{max} \\ v_{abs,r} \times v_{rel,r} &< 0 & c_{s,r} &= c_{min} \end{aligned} \quad (4-b)$$

#### B. Continuous Skyhook Control

An extension of the on-off skyhook control policy was used as one method of continuous control. Considering a 4DOF

system with a skyhook damper, the hypothetical damper stand between inertial reference and body, the damping force for one side of system (for example, left side) can be written as:

$$F_{sky} = c_{sky} \times v_{abs,l} \quad (5)$$

Where  $F_{sky}$  is the skyhook damping force,  $v_{abs,l}$  is the absolute velocity of the mass and  $c_{sky}$  is the damping coefficient of the skyhook damper. The intention is to replicate such a skyhook damping force with a semi-active damper mounted conventionally between the sprung and unsprung mass.

However, since a passive damper can only absorb vibration energy, the product of the semi-active damping force,  $F_{sa}$ , and the relative velocity,  $v_{rel,l}$ , across the damper must satisfy the below inequality:

$$F_{sa} \times v_{rel,l} \geq 0 \quad (6)$$

The desired force is  $c_{sky} v_{abs,l}$ , but the semi-active damper can only generate this force when  $v_{abs,l}$  and  $v_{rel,l}$  have the same sign. When  $v_{abs,l}$  and  $v_{rel,l}$  are of opposite sign, the semi-active damper can only provide a force opposite to the desired force. In this situation, it is better to supply no force at all. Thus, the value that  $c_{s,l}$  must take to emulate a skyhook damper may be found by these relations:

#### Left Damper:

$$\begin{aligned} v_{abs,l} \times v_{rel,l} \geq 0 & \quad c_{s,l} = c_{sky} \cdot v_{abs,l} / v_{rel,l} \\ v_{abs,l} \times v_{rel,l} < 0 & \quad c_{s,l} = 0 \end{aligned} \quad (7-a)$$

#### Right Damper:

$$\begin{aligned} v_{abs,r} \times v_{rel,r} \geq 0 & \quad c_{s,r} = c_{sky} \cdot v_{abs,r} / v_{rel,r} \\ v_{abs,r} \times v_{rel,r} < 0 & \quad c_{s,r} = 0 \end{aligned} \quad (7-b)$$

One can see from (7) that when the relative velocity is very small, the required damping coefficient increases abruptly and tends to infinity. However, in practice the semi-active damper coefficient is limited by the physical parameters of the conventional damper, which means that there is both an upper bound,  $c_{max}$ , and a lower bound,  $c_{min}$  [1]. The damping coefficient in (7) can thus be rewritten as:

#### Left Damper:

$$\begin{aligned} v_{abs,l} \times v_{rel,l} \geq 0 & \quad c_{s,l} = \max\{c_{min}, \min[(c_{sky} \cdot v_{abs,l} / v_{rel,l}), c_{max}]\} \\ v_{abs,l} \times v_{rel,l} < 0 & \quad c_{s,l} = c_{min} \end{aligned} \quad (8-a)$$

#### Right Damper:

$$\begin{aligned} v_{abs,r} \times v_{rel,r} \geq 0 & \quad c_{s,r} = \max\{c_{min}, \min[(c_{sky} \cdot v_{abs,r} / v_{rel,r}), c_{max}]\} \\ v_{abs,r} \times v_{rel,r} < 0 & \quad c_{s,r} = c_{min} \end{aligned} \quad (8-b)$$

## IV. NUMERICAL SIMULATION

Since discussed about the semi-active control strategies, the computer program used to simulate the vehicle roll-plane

model. The dynamics formulation expressed in Section II and control algorithm exerted to them are solved for base excitations.

The parameters of the system considered for these simulations are presented in Table I [9]. The natural frequencies of model which are obtained by the parameters given in Table I and  $c_{s,l} = c_{s,r} = 1290$  (Ns/m) are equal  $\omega n_1 = 1.13\text{Hz}$ ,  $\omega n_2 = 1.54\text{Hz}$ ,  $\omega n_3 = 10.93\text{Hz}$ ,  $\omega n_4 = 11.02\text{Hz}$ .

TABLE I  
MODEL PARAMETERS [9]

parameter	Value	Unit	parameter	Value	Unit
$m_b$	730	Kg	$d_{b,l}$	0.761	m
$m_{t,l}$	40	Kg	$d_{b,r}$	0.761	m
$m_{t,r}$	40	Kg	$k_{s,l}$	19960	N/m
$I_{xx}$	230	Kg.m <sup>2</sup>	$k_{s,r}$	19960	N/m
$c_{min}$	258	Ns/m	$k_{t,l}$	175500	N/m
$c_{max}$	2838	Ns/m	$k_{t,r}$	175500	N/m
$c_{sky}$	1290	Ns/m			

The finite difference method is employed for solution of the system dynamics equations. The programming of these Simulations carried out in MATLAB.

In this study, the response of system in terms of body acceleration, roll angle and tire heave displacement used as a performance index to evaluate vibration isolation and vehicle stability performance for named control schemes.

## V. RESULTS AND DISCUSSION

In this part, frequency analysis and transient analysis of model are investigated.

### A. Frequency Analysis

For analysis of the system through a frequency domain approach, a harmonic input in form  $A \sin(\omega t)$  is exerted only to the left tire.  $A$  is amplitude of input which is equal 1 cm in this simulation and  $\omega$  is input frequency. The responses are studied in form RMS for various frequencies in range 0.1 to 20 HZ. The results of analysis for controlled system through on-off and continuous skyhook strategies are shown in Fig. 3 in comparison with the passive suspension.

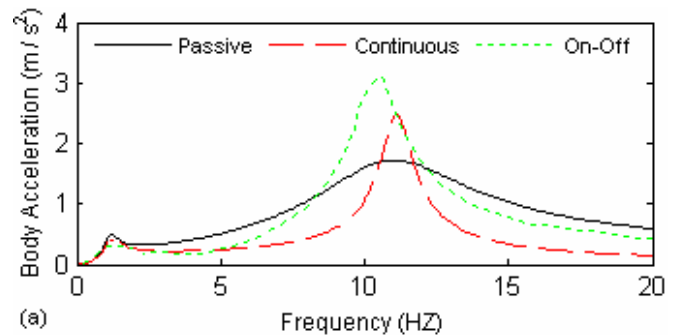

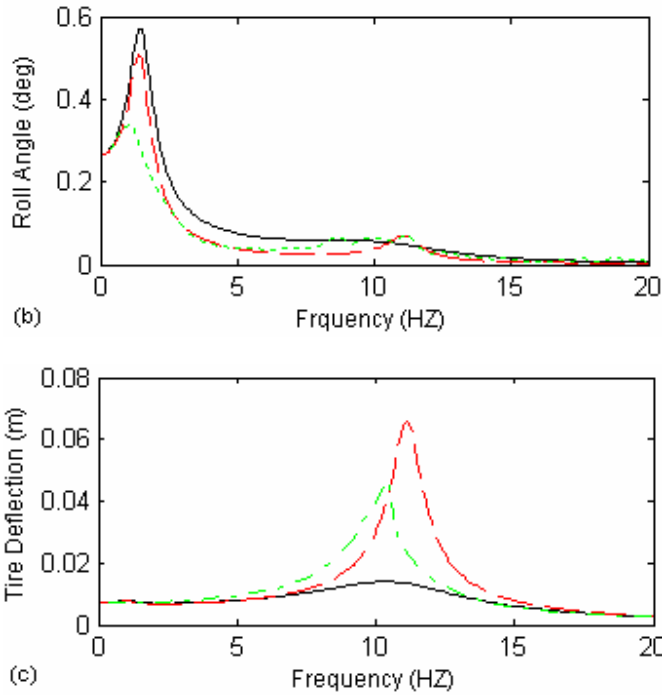

Fig. 3 Frequency analysis of 4DOF model  
a) Body acceleration b) Roll angle c) Tire deflection

**B. Transient Analysis**

The response dynamics for transient input are evaluated for both types of control strategies and passive model. The transient input chosen for this study is a step input with maximum value 5(cm) that exerted to the left tire. Fig. 4 shows responses for this analysis.

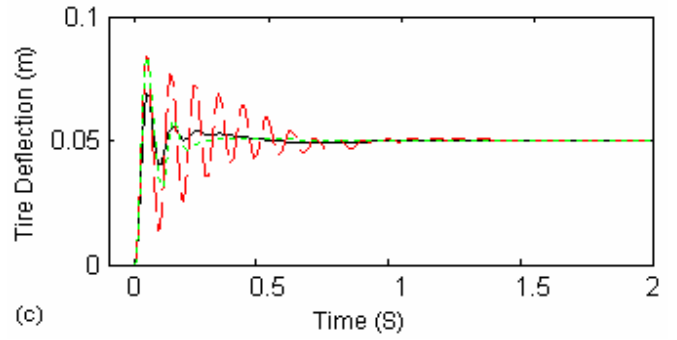
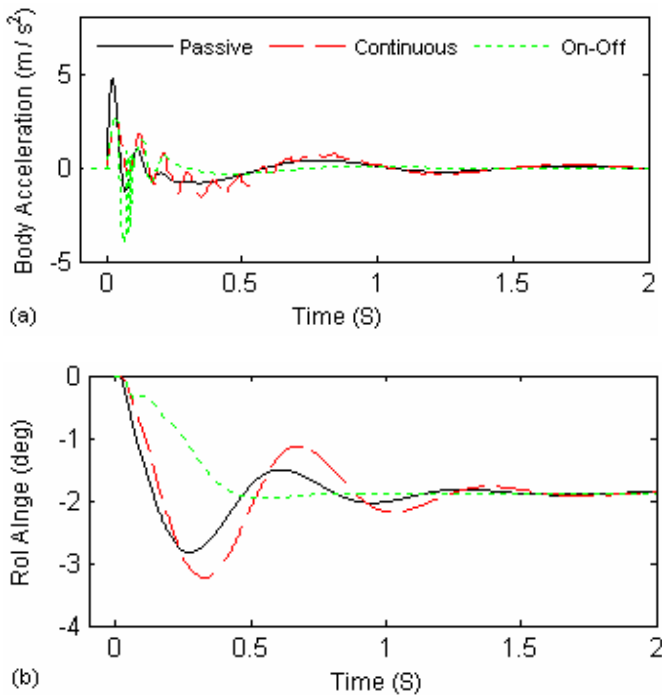

Fig. 4 Transient analysis of 4DOF model  
a) Body acceleration b) Roll angle c) Tire deflection

**C. Steady State Analysis**

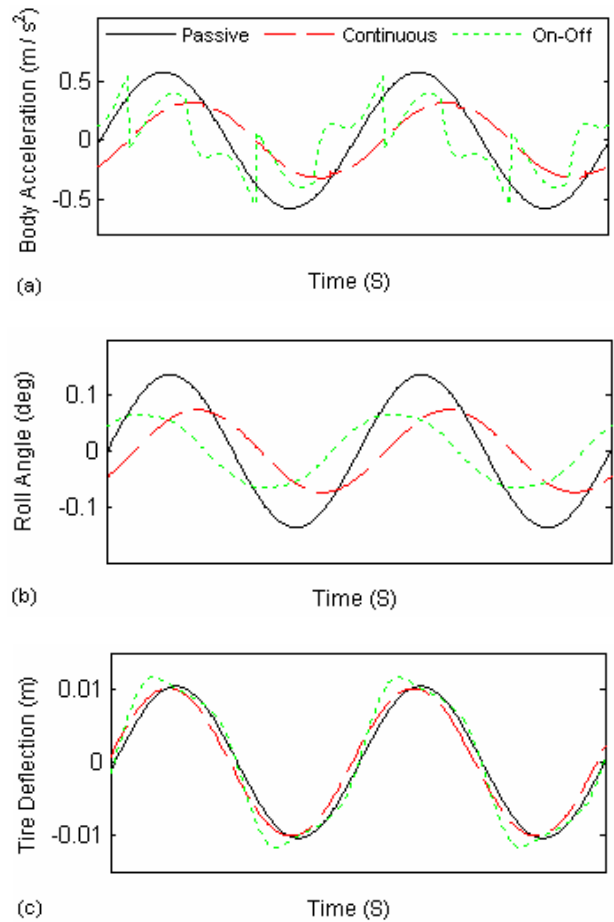

Fig. 5 Steady state analysis of 4DOF model ( $\omega=4$  HZ)  
a) Body acceleration b) Roll angle c) Tire deflection

This part evaluates the performance of both control techniques under steady state conditions. The input chosen for this portion of study is as similar as frequency analysis. The system was allowed to run until steady state was reached, but only the last few cycles are plotted here. The responses of model for this input are shown in Fig. 5.

Fig. 3 (a) shows the body acceleration frequency response. It is observed that the RMS body acceleration is reduced by

using semi-active suspension in all frequencies except at tires natural frequencies. Continuous skyhook strategy is more effective than on-off in reduction of vertical body acceleration, but it is considerable that thus value is less through on-of strategy than continuous strategy in body natural frequency. The results of transient analysis show reduction of body acceleration peak. It can be seen that chatter is increased and settling time is decreased through the on-off strategy. Fig. 5(a) shows decrease in value of body acceleration specially via continuous skyhook control scheme. Also, the acceleration response of the On-off damper consistently reveals some jerks during each vibration cycle. These jerks occur at the instances at which the damper is switched on and off.

Frequency analysis of the roll angle is investigated in Fig. 3(b). It can be seen that roll angle is reduced through on-off and continuous strategy in comparison with passive model as similar as vertical body acceleration. It is considered that the on-off strategy gives better result than the continuous control scheme at body natural frequency. Response of step input shows the roll angle is decreased through on-off strategy. Also, it is seen that the roll angle has decreased with respect to passive model through both control strategies in Fig. 5(b).

Tire deflection results show that so change isn't seen in tire deflection through both control strategies with respect to passive model except at tire natural frequencies. Also, this orser has shown in Fig 5(c) for sinusoidal input at frequency 4 HZ. Fig 4(c) shows the increasment in vertical tire deflection whereas the input is step.

Fig. 6 shows sample time history of skyhook execution for continuous and on-off damper.  $v_{abs,1}$  and  $v_{rel,1}$  plotted in figures are shown more greater than real values.

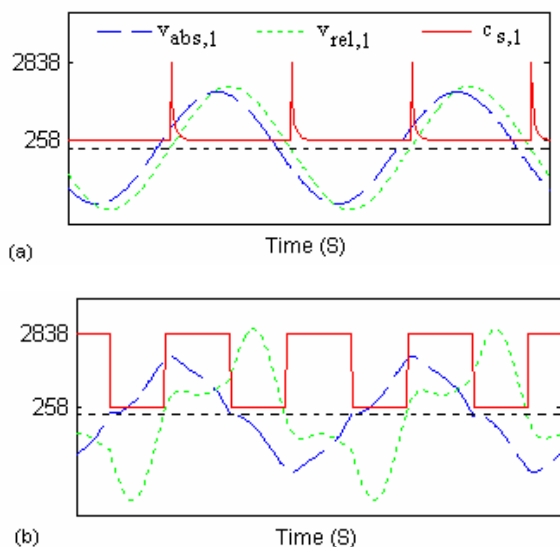

Fig. 6 Sample time history of skyhook execution  
a) Continuous b) On-Off

## VI. CONCLUSION

For studying skyhook control effect on suspension system of viewpoint ride comfort, a model of 4DOF system subject to the base excitation has been used to study the vibration isolation performance of semi-active dampers. It can be concluded from the results that the semi-active systems considered can always provide better isolation at all frequencies than a conventional passive damped system excepted of tire natural frequency. The on-off skyhook system is much simpler than the continuous skyhook system. The results of both of them are acceptable but the jerks produced in the on-off model are more than continuous model. So, for this reason, ride comfort is more achievable with continuous model than that on-off model. Nonetheless, as much as continuous strategy is succeder in ride comfort, the on-off strategy is succeder in vehicle stability.

## REFERENCES

- [1] Y. Liu, T.P. Waters, M.J. Brennan, "A comparison of semi-active damping control strategies for vibration isolation of harmonic disturbances" *Sound and Vibration J.*, vol. 280, pp. 21-39, 2003.
- [2] J. P. Hyvärinen, *The Improvement of Full Vehicle Semi-Active Suspension Through Kinematical Model*, Oulo University Press, 2004.
- [3] D. C. Karnopp, M. J. Crosby, R. A. Harwood, "Vibration control using semi-active force generators" *Engineering for Industry J.*, vol. 96, no. 2, pp. 619-626, 1974.
- [4] D. C. Karnopp, "Design principles for vibration control systems using semi-active dampers" *Dynamic Systems, Measurement, and Control J.*, vol. 112, pp. 448-455, 1990.
- [5] F. D. Goncalves, "Dynamic Analysis of Semi-Active Control Techniques for Vehicles Applications" M.S. thesis, Dept. Mech. Eng., Virginia Polytechnic Institute and State University, Virginia, 2001.
- [6] A. K. Carter, "Transient Motion Control of Passive and Semi-active Damping for Vehicle Suspensions" M.S. thesis, Dept. Electron. Eng., Virginia Polytechnic Institute and State University, Blacksburg, Virginia, 1998.
- [7] E. J. Krasnicki, "Comparison of analytical and experimental results for a semi-active vibration isolator" *Shock and Vibration Bulletin.*, vol. 50, pp. 69-76, 1980.
- [8] E. J. Krasnicki, "The experimental performance of an on-off active damper" 51st Shock and Vibration Symposium, San Diego, USA, 1980.
- [9] E. D. Blanchard, "On the Control Aspects of Semi active Suspensions for Automobile Applications" M.S. thesis, Dept. Mech. Eng., Virginia Polytechnic Institute and State University, Blacksburg, Virginia, 2003.