

Fatigue Properties of Steel Sheets Treated by Nitrooxidation

M. Maronek, J. Barta, P. Palcek, K. Ulrich

Abstract—Low carbon deep drawing steel DC 01 according to EN 10130-91 was nitrooxidized in dissociated ammonia at 580°C/45 min and consequently oxidised at 380°C/5 min in vapour of distilled water. Material after nitrooxidation had 54 % increase of yield point, 34 % increase of strength and 10-times increased resistance to atmospheric corrosion in comparison to the material before nitrooxidation. The microstructure of treated material consisted of thin ϵ -phase layer connected to layer containing precipitated massive needle shaped Fe_4N - γ' nitrides. This layer passed to a diffusion layer consisting of fine irregular shaped Fe_{16}N_2 - α'' nitrides regularly dispersed in ferritic matrix. Fatigue properties were examined under bending load with frequency of 20 kHz and sinusoidal symmetric cycle. The results confirmed positive influence of nitrooxidation on fatigue properties as fatigue limit of treated material was double in comparison to untreated material.

Keywords—steel sheet, fatigue, nitrooxidation, S-N diagram

I. INTRODUCTION

A field of ultra-high cycle fatigue ($10^7 < N < 10^{10}$ cycles) has been for past ten years centre of the interest of research institutes oriented to improvement of a lifetime, safety and reliability of machine parts and constructions [1]. The time as the main demand factor substantiates use of equipments working at frequencies about 20 kHz.

Degradation fatigue process and initiation of fatigue cracks are in close relation to surface and subsurface material properties. There is very often discussed priority of surface or subsurface initiation with regard to number of cycles (low, high, ultra high). On the other hand, this is closely linked with micropurity, homogeneity and heterogeneity of materials, size and shape of their structural phases as well as with questions of material surface treatment.

A nitrooxidation is thermo-chemical diffusion method of material surface treatment which significantly improves mechanical and tribological properties of materials and increases their corrosion resistance.

M. Maronek is with the Slovak University of Technology, Faculty of Materials Science and Technology, J. Bottu 25, 91701 Trnava, Slovakia (phone: +421-906-068-344; e-mail: milan.maronek@stuba.sk).

J. Barta is with the Slovak University of Technology, Faculty of Materials Science and Technology, J. Bottu 25, 91701 Trnava, Slovakia (phone: +421-906-068-305; e-mail: jozef.barta@stuba.sk).

P. Palcek is with the Faculty of Mechanical Engineering at the University of Žilina, Univerzitná 1, 010 26 Žilina, Slovakia (phone: +421-41-513-6004; e-mail: milan.maronek@stuba.sk).

K. Ulrich is with the Slovak University of Technology, Faculty of Materials Science and Technology, J. Bottu 25, 91701 Trnava, Slovakia (phone: +421-906-068-369; e-mail: koloman.ulrich@stuba.sk).

The nitrooxidation process developed by German company Degussa is quite well known as TENIFER QPQ process [2] in nitrogen salts, but application of this process by utilizing fluid technology is not so known despite its less environmental side effects and lower cost comparing to nitrogen salts and cyanides typical for process TENIFER QPQ.

The nitrooxidation process in fluid environment consists of nitridation and subsequent oxidation. Surface of material is during nitridation saturated by nitrogen responsible for formation of hard nitride layer. The materials are nitrided in dissociated ammonia that serves simultaneously as a medium for wafting the Al_2O_3 which stands for heat accumulator. The nitridation is followed by oxidation in vapour of distilled water, supplied to the furnace chamber.

Previous research of steel sheets treated by nitrooxidation has been focused on their technological processing, e. g. welding [3], [4] and forming [5]. In relation to further application of these materials in praxis as well as widening the scientific knowledge it seems to be interesting to find out their fatigue behaviour.

This paper describes the influence of nitrooxidation on fatigue behaviour of low carbon deep drawing steel DC 01 EN 10130-91.

II. BACKGROUND

Process of nitrooxidation significantly improves corrosion resistance and comparing to zinc coated sheets also improves mechanical properties. The technological properties, e. g. forming are slightly decreased.

A. Tensile Test

The transverse tensile test was carried out according to STN EN 895 and STN EN 10002-1:2001 standards on samples before and after nitrooxidation. Data obtained and calculated from the tensile test are shown in Table 1.

TABLE I
MEASURED VALUES AT TENSILE TEST

Material	Re [MPa]	Rm [MPa]	A [%]
Before nitrooxidation	200	282.3	31.2
After nitrooxidation (nitridation 580 °C/45 min, oxidation 350°C/5 min)	308	377.3	23.7

B. Corrosion Properties

Nitrooxidised steel showed 10-times increased resistance to atmospheric corrosion compared to basic state steel. Only two of sampled area was attacked after 240 hours in condensed water test cabinet **Error! Reference source not found.**].

C. Formability

During the Erichsen cupping test there was observed 15 % decrease of Erichsen cupping index (IE) for nitrooxidised steel in comparison to non-treated steel. The Fukui conical cup test **Error! Reference source not found.**] involving both stretching and drawing over a ball showed 1.5 % increase of conical cup value (CCV). Precipitated nitrides had no influence on the microstructure changes during forming and caused no failure in the surface layer of formed nitrooxidised steel. The Erichsen and Fukui tests confirmed the nitrooxidation process does not radically reduce the material's drawability **Error! Reference source not found.**].

D. Structural Characteristics

The samples were polished, etched in 3% Nital and observed by scanning electron microscope TESCAN VEGA II. Fig. 1 shows structure of DC 01 steel after nitrooxidation (nitridation 580 °C/45 min, oxidation 350°C/5 min). Thin (1–3 µm in thickness) continuous surface layer of Fe₂O₃ a Fe₃O₄ oxides was observed.

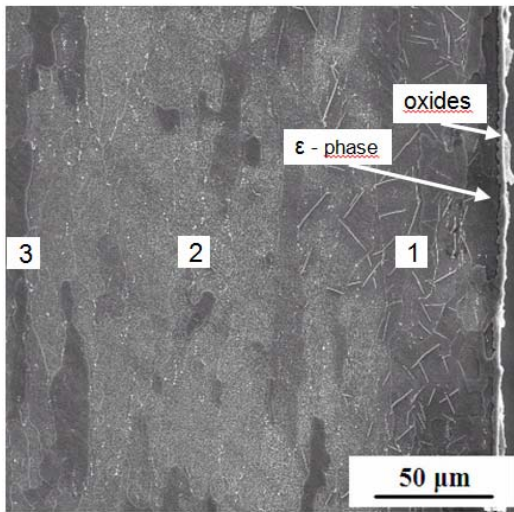

Fig. 1 Structure of DC 01 steel after nitrooxidation

Beneath the oxidic layer, the coherent layer of ε phase (Fe₃N) was identified. This layer was connected to ferritic matrix with precipitated massive needle shaped Fe₄N - γ' nitrides (Fig. 2). Thickness of this layer was approximately 50 µm.

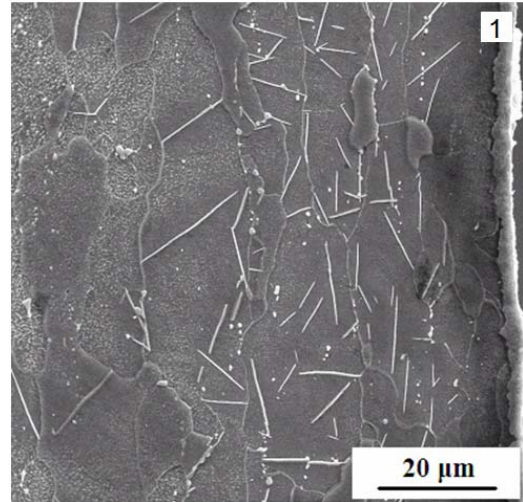

Fig. 2 Coarse needles of Fe₄N nitrides

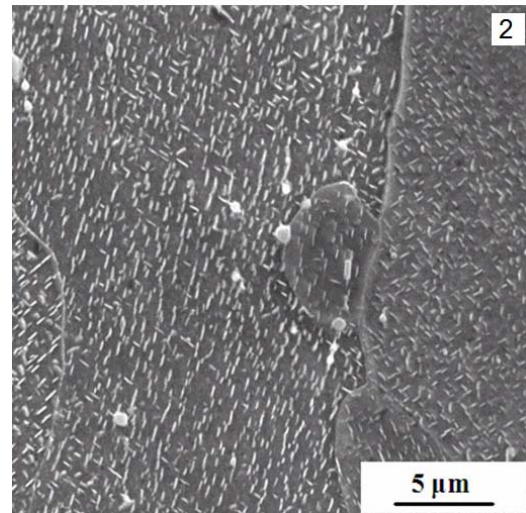

Fig. 3 Fine Fe₁₆N₂ nitrides regularly dispersed in ferritic matrix

Another part of material influenced by the nitrooxidation process was the diffusion zone of 150 µm in thickness (Fig. 3). This zone consisted of fine irregular shaped Fe₁₆N₂ - α'' nitrides regularly dispersed in ferritic matrix. The structure under this zone consisted of initial ferritic matrix with very fine carbides (Fig. 4). Arrow in Fig. 4 shows direction of sheet rolling process resulting to elongation of polygonal grains. This analysis is in good correlation with work [8].

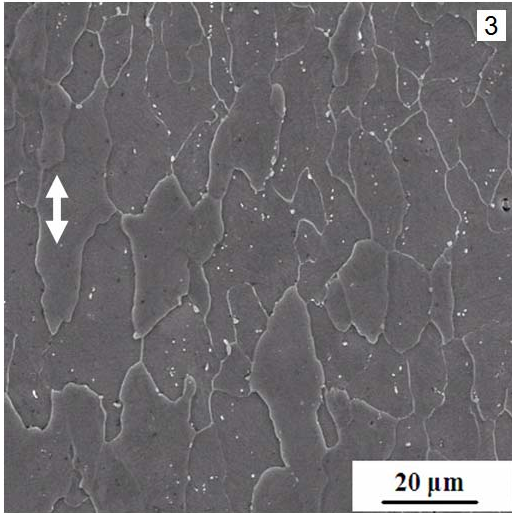

Fig. 4 Polygonal grains of ferritic structure elongated in direction of sheet rolling process

III. EXPERIMENTAL

The investigation used 1 mm thick low-carbon deep-drawing steel DC 01/DIN EN 10130-9 treated by nitrooxidation process in fluidised layer. Typical chemical composition of used material before the treatment shows Table 2.

TABLE II
TYPICAL CHEMICAL COMPOSITION OF EXPERIMENTAL STEEL [WT. %]

EN code	C	Mn	P	S	Si
DC 01	0,12	0,60	0,045	0,045	0,1

Dimensions and shape of samples (Fig. 5) were designed in order to comply with resonance requirements of high frequency load. The fatigue tests were done at room temperature ($T = 20 \pm 3 \text{ }^\circ\text{C}$), but during the high frequency oscillation the significant heat up of samples occurred. In order to prevent this, the samples had to be cooled by distilled water containing anticorrosive inhibitor.

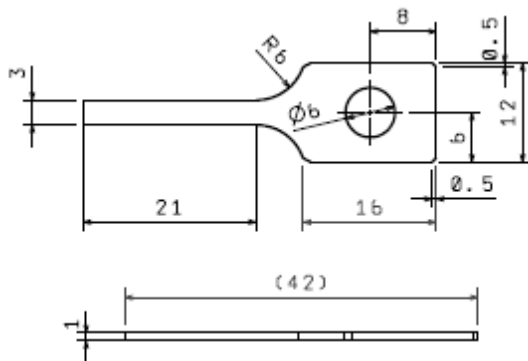

Fig. 5 High frequency fatigue test samples

The fatigue tests were carried out by ultrasonic fatigue equipment KAUP at University of Zilina, Slovakia (Fig. 6). The equipment consists of piezoceramic transducer, strain cone concentrator, power supply and measurement unit. The fatigue tests were done under bending load with frequency of 20 kHz and sinusoidal symmetrical cycle. The system worked at peak zone of resonance curve.

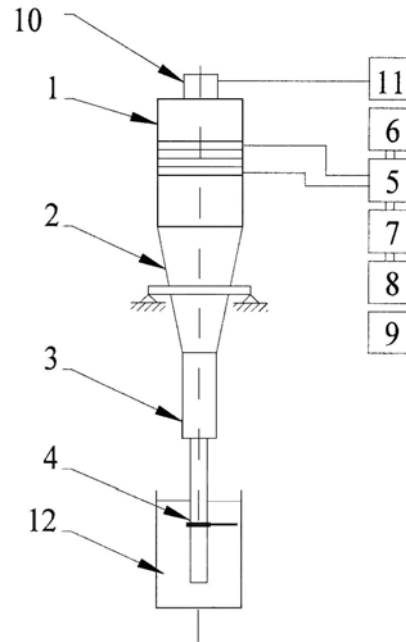

Fig. 6 Scheme of testing equipment KAPU

1 – piezoceramic transducer, 2 – cone concentrator, 3 – stepped concentrator, 4 – test sample, 5 – ultrasonic generator, 6- transformer, 7 – frequency counter, 8– recorder, 9 - digital chronometer, 10– catcher of displacement amplitude, 11 - millivoltmeter, 12 – coolant.

IV. RESULTS

The results of high frequency fatigue tests of DC 01 steel sheets under bending load are presented as S-N curves (i. e. stress σ_a dependence on number of cycles to failure N_f) in Fig. 7. The measurements were carried out in the amplitude range $\sigma_a = (260 \div 80) \text{ MPa}$ responding to number of cycles to failure from $N_f \approx 8 \times 10^5$ cycles to $N \approx 2 \times 10^8$ cycles. This diagram compares fatigue behaviour of steel sheets before (black points) and after (grey points) nitrooxidation. All samples were cycled until their failure. Fatigue strength of limited lifetime can be characterized in both cases by curve fitted to the experimental points corresponding to fractured samples using least squares method. The equation for material before nitrooxidation is:

$$\sigma_a = 522N_f^{-0,102}, \tag{1}$$

with coefficient of determination $R^2 = 0.81$.

The S-N equation for steel sheet treated by nitrooxidation is:

$$\sigma_a = 775N_f^{-0,0845}, \tag{2}$$

with coefficient of determination $R^2 = 0,59$.

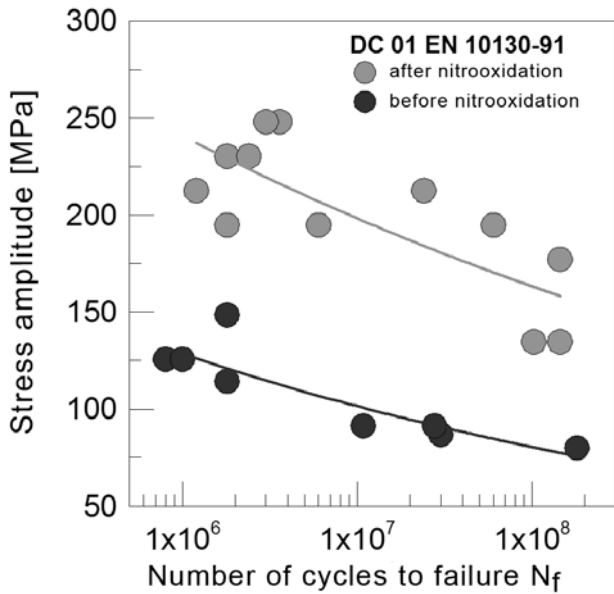

Fig. 7 The results of fatigue tests for steel sheets DC 01 in the form of S-N curves

There is obvious that fatigue life of both test groups determined by experiment continuously declines from high to ultra-high fatigue zone. Declining stress amplitude leads to increase of number of cycles to failure, i. e. increase of fatigue life. Number of cycles to failure has significant straggling especially in the case of material after nitrooxidation treatment (the coefficient of determination R^2 is considerably lower in comparison to material before nitrooxidation). For example, at the strain amplitude level of 210 MPa, one sample treated by nitrooxidation fractured after 1.2×10^6 cycles while another one after 2.4×10^7 cycles. Regardless this, the Fig. 7 shows the fatigue life of steel sheets before nitrooxidation which is significantly lower in the whole range of cyclic loading. There was also determined fatigue limit σ_c as the face value for $N_f = 10^8$ cycles to failure. They were $\sigma_{c10^8} = 100$ MPa and $\sigma_{c10^8} = 200$ MPa for material before and after nitrooxidation respectively.

A. Fractographic Analysis

Fractographic analysis of fatigue fracture surfaces proved, the fatigue cracks in the case of sheets without nitrooxidation were initiated mostly simultaneously from both sides of sheet (Fig. 8). This way initiated cracks were propagating by fatigue mechanism into the middle of the sheet thickness where the remaining part of sheet cross-section was broken by the ductile fracture with its characteristic morphology.

In the case of material treated by nitrooxidation initiation of fatigue cracks was multiple. The fatigue cracks were initiated mostly from the corner edge of the sheet (Fig. 9) as well as its surface (Fig. 10).

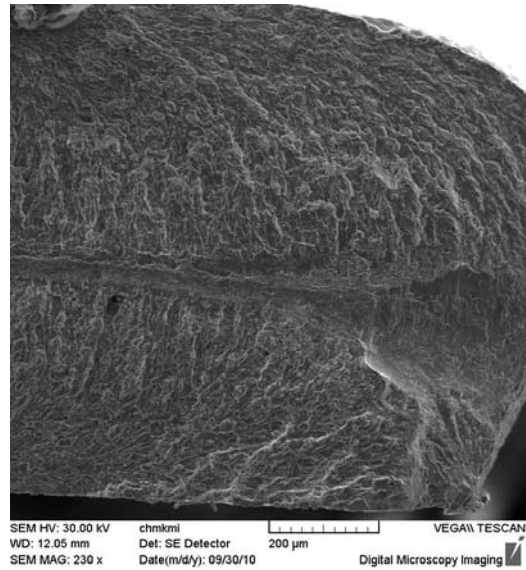

Fig. 8 Appearance of fatigue fracture of material without nitrooxidation. Symmetrical fatigue crack propagation from both side of steel sheet

The fatigue cracks were then propagating by transcrystalline fatigue mechanism exhibiting the characteristic fields of striations.

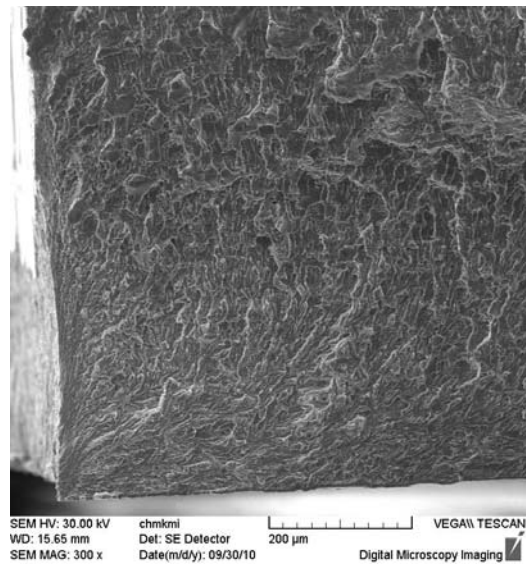

Fig. 1 Initiation Of Fatigue Crack At Corner Edge Of Material Treated By Nitrooxidation

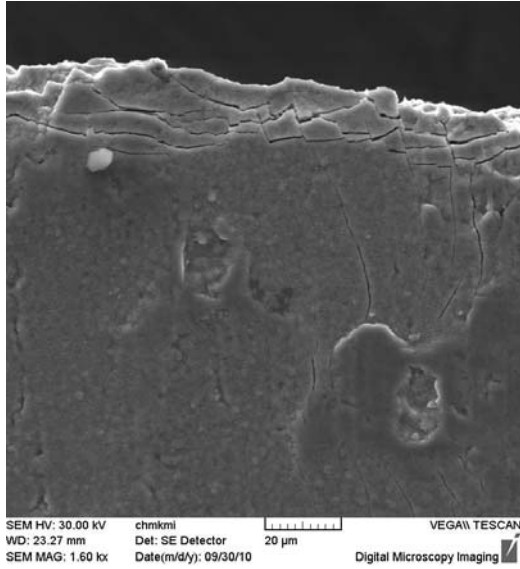

Fig. 10 Cracked nitridic layer at sheet surface in the place of fatigue crack initiation

The final fracture was also in this case situated into the middle of the sheet thickness (Fig. 11), or in its upper or lower edge in dependence on the location of major initiation and propagation of main fatigue crack. Character of final fracture was also transcrystalline with dimple morphology (Fig. 12). There was observed cracking of thin and brittle surface oxidic layer during crack initiation or final fracture of sheets treated by nitrooxidation (Fig. 13). Nitridic layer was broken entirely by ductile fatigue mechanism and there was possible to identify singular nitridic particles after etching the fracture surface (Fig. 14).

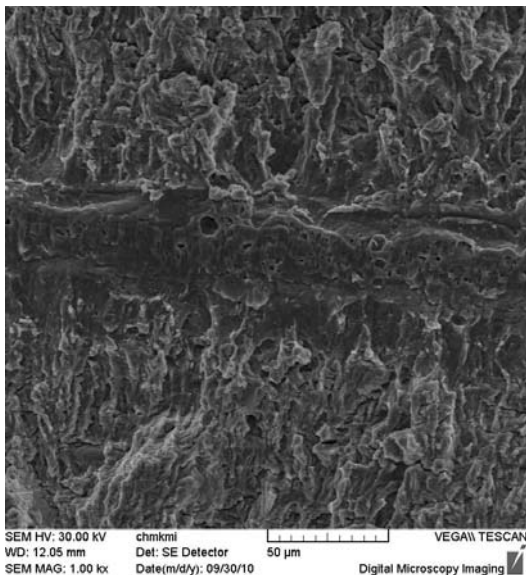

Fig. 11 The placement of final fracture into the middle of the sheet thickness

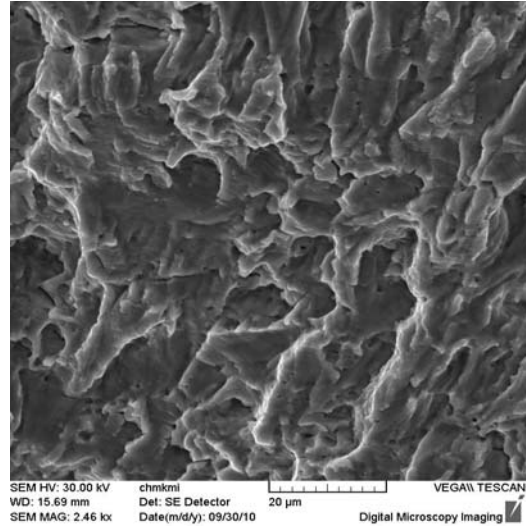

Fig 12 Transcrystalline fatigue failure in zone of stable fatigue crack growth through cross section of treated material

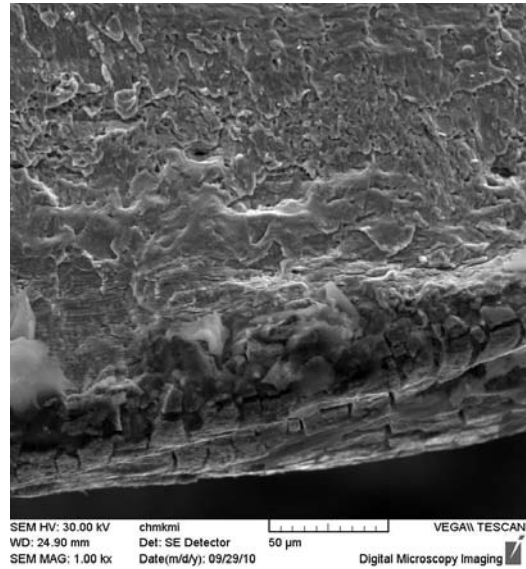

Fig. 13 Cracked oxidic layer of nitrooxidised sheet surface at final fracture zone

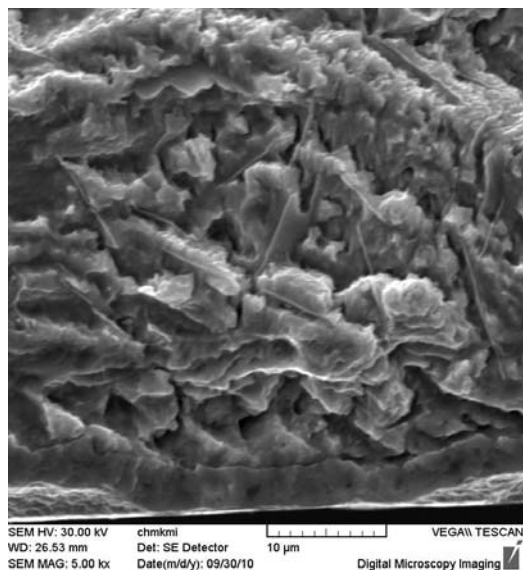

Fig. 14 Close-up of cracked oxidic layer and coarse nitridic needles in the place of fatigue crack initiation

V. CONCLUSIONS

The nitrooxidation process has positive influence on fatigue life of steel sheets. Fatigue limit of steel after nitrooxidation was two times higher than fatigue limit of material without treatment. Based on fractographic examination there can be concluded the nitrooxidation layer significantly extends phase of fatigue cracks initiation and thus extends the total fatigue life of treated material. Moreover, the layer has no influence on mechanism of crack initiation and propagation. Subsurface initiation of fatigue cracks originated from inside defects occurring in nitrided high strength steels was not observed here.

ACKNOWLEDGEMENT

This paper was realised within the support of Slovak Research and Development Agency, grant No. 0057-07.

REFERENCES

- [1] F. Novy, M. Cincala, P. Kopas, O. Bokuvka, *Mechanisms of high-strength structural material fatigue failure in ultra-wide life region*. In: *Materials Science & Engineering – A* - Vol. 462, No. 1-2 (2007). p. 189-192. - ISSN 0921-5093.
- [2] J. Bosslet, M. Kreutz, “*TUFFTRIDE®-/QPQ®-Process*”, promotional material available online: http://www.durferrit.com/media/pdf/Tenifer_QPQ_eng.pdf
- [3] M. Maronek, J. Barta, R. Lazar, M. Domankova, I. Kovarikova, “*Laser beam welding of steel sheets treated by nitrooxidation*,” In: *61st Annual Assembly and International Conference of the International Institute of Welding*: Graz, Austria, 6-11 July 2008. Graz, 2008. - p. 1-8
- [4] M. Maronek, J. Barta, M. Domankova, F. Kolenic, “*Comparison of laser and electron beam welding of steel sheets treated by nitrooxidation*.” In: *Congresso da ABM* (CD-ROM). - ISSN 1516-392X. - 65th ABM international congress. 18th IFHTSE congress. 1st TMS/ABM : Brazil, Rio de Janeiro, 2010 July 26th to 30th. - Rio de Janeiro : Associação Brasileira de Metalurgia, Materiais e Mineração, 2010, p. 4925-4937

- [5] R. Lazar, “*Influence of nitrooxidation on mechanical properties and deep-drawing property of low-alloy deep-drawing sheet metals*.” In: *IV. elektronnaja zaocnaja konferencija "Molodez, studencstvo, nauka XXI. veka"*. - Izevsk : IZGTU, 2004. - ISBN 5-7526-0185-1. - p. 76-79
- [6] T. Kunikova, R. Lazar, M. Domankova, L. Moskova, Z. Kamasova-Marekova, “*Evaluation of corrosion resistance of nitrided and nitrooxidised low-carbon steel*.” In: *CO-MAT-TECH 2005: Proceedings/ International Scientific Conference*, 13th, Trnava, Slovak Republic, 20-21 October 2005. Bratislava: STU in Bratislava, 2005. - ISBN 80-227-2286-3., p. 671-678
- [7] K. Pöhlandt, A.E. Tekkaya, “*Formability of Metallic Materials*” (Plastic Anisotropy, Formability Testing and Forming Limits), Editor: Banabic D., Springer Verlag, Heidelberg-Berlin, 2000 (358 pag), ISBN 3-540-67906-5.
- [8] R. Lazar, M. Domankova, P. Kotras, “*Analysis of nitrooxidation layer of deep-drawing sheet metals with using TEM and X-Rays*.” In: *Materials Science and Technology* [online]. - ISSN 1335-9053. 2005