

Evaluation of Power Consumption of Spanke Optical Packet Switch

V. Eramo, E. Miucci, A. Cianfrani, A. Germoni, and M. Listanti

Abstract—The power consumption of an Optical Packet Switch equipped with SOA technology based Spanke switching fabric is evaluated. Sophisticated analytical models are introduced to evaluate the power consumption versus the offered traffic, the main switch parameters, and the used device characteristics. The impact of Amplifier Spontaneous Emission (ASE) noise generated by a transmission system on the power consumption is investigated. As a matter of example for 32×32 switches supporting 64 wavelengths and offered traffic equal to 0,8, the average energy consumption per bit is $5,07 \cdot 10^{-2}$ nJ/bit and increases if ASE noise introduced by the transmission systems is increased.

Keywords—Spanke, Amplifier Spontaneous Emission Noise, Power Consumption, Optical Packet Switch.

I. INTRODUCTION

ENERGY efficiency can be considered as one of the biggest challenges in a large part of industrial and research fields. This arises from the need of reducing the energy related expenses of enterprises, industries as well as residential buildings, while keeping an eye on targets for the reduction of greenhouse gas emissions [1]. For example, as shown in [2], energy consumption of Telecom Italia network in 2006 has reached more than 2TWh (about 1% of the total Italian energy demand), increasing by 7.95% with respect to 2005, and by 12.08% to 2004. Another explanatory example is represented by British Telecom, which absorbed about 0.7% of the total UK's energy consumption in the winter of 2007, making it the biggest single power consumer in the nation [2]. Moreover, as evidenced in [3], about 10% of the UK's entire power consumption in 2007 was related to operating IT equipment.

Research has been initiated in recent years for energy saving of the Internet. This effort has been called "Greening the Internet". Several promising technologies have been being proposed from the component level to the network level [4].

Other solutions are based on power-aware system design that leads to reduce the power consumption of the electronic routers. The optical switch [5]-[6] has long been considered the primary candidate for replacing the electronic routers. For lacking of optical buffer, buffeless Optical Packet Switches are promising nodes in reducing the power consumption [8]. To solve output packet contentions they use the wavelength domain. Contending packets are wavelength converted by using Wavelength Converters (WC). Due to the high power consumption of WCs, especially for bit-rate increasing, Optical Packet Switch (OPS) architectures with shared WCs have

been defined [8]. In some cases they allows us to reduce by 80% the power consumption with respect to OPS in which no WCs sharing is performed [8].

In this paper we propose an analytical model to evaluate the average energy consumption per bit of an Optical Packet Switch equipped with a Spanke switching fabric realized in Semiconductor Optical Amplifier (SOA) technology. Sophisticated analytical models are introduced to evaluate the power consumption of the devices, in particular SOAs, needed to realize the switching fabric. The introduced models allow us to evaluate the impact that Amplifier Spontaneous Emission (ASE) noise, generated by a transport system, has on the SOA's power consumption due to the SOA gain saturation. By means of the these models, we are able to evaluate the average energy consumption per bit of the Spanke switch as a function of the main system and traffic parameters and versus the characteristic of the transmission system (length, number of amplifiers, ...).

The remainder of the paper is organized as follows. Section II describes the Spanke switch. An analytical model evaluating the average energy consumption per bit in Spanke switches versus the offered traffic, the switch parameters and the characteristics of the transmission system is described in Section III. The main numerical results are illustrated in Section IV where we provide some results on the power consumption of the Spanke switch. Finally Section V provides some final remarks and concludes the paper.

II. SPANKE OPTICAL PACKET SWITCH

The studied general switching architecture is reported in Fig. 1. It is equipped with N input/output fibers (IF/OF) where each IF/OF supports M wavelengths channels. Let λ_i ($i = 0, \dots, M - 1$) be the wavelengths carried on each OF. In order to save power consumption, the OPS is equipped with fully shared Wavelength Converters (WC). Packets not requiring wavelength conversion are directly routed towards the Output Fibers (OF). On the contrary packets requiring wavelength conversion will be directed to a pool of WCs, wavelength converted and next routed to the OF to which they are directed.

An Optical Packet Switching architecture equipped with Spanke switching fabric realized in Semiconductor Optical Amplifier (SOA) technology is studied. An example of Spanke switch is illustrated in Fig. 2 in the case $N=2$, $M=2$ and $r=1$. A full pool of r Wavelength Converters is shared among the arriving packets. The selection of either an OF or a WC is realized by turning on one Semiconductor Optical Amplifier (SOA) of a $1 \times (N + r)$ Space Switching Module (SSM) of

V. Eramo, L. Piazza, M. Listanti and A. Cianfrani are with the Department of Information, Electronic and Telecommunications Engineering, Sapienza University of Roma, Via Eudossiana 13, 00184 Rome, Italy e-mail: (see <http://net.infocom.uniroma1.it/homepages/eramov>).

A. Germoni is with Co.Ri.Tel., Via Cavour 256, 00184, Rome, Italy

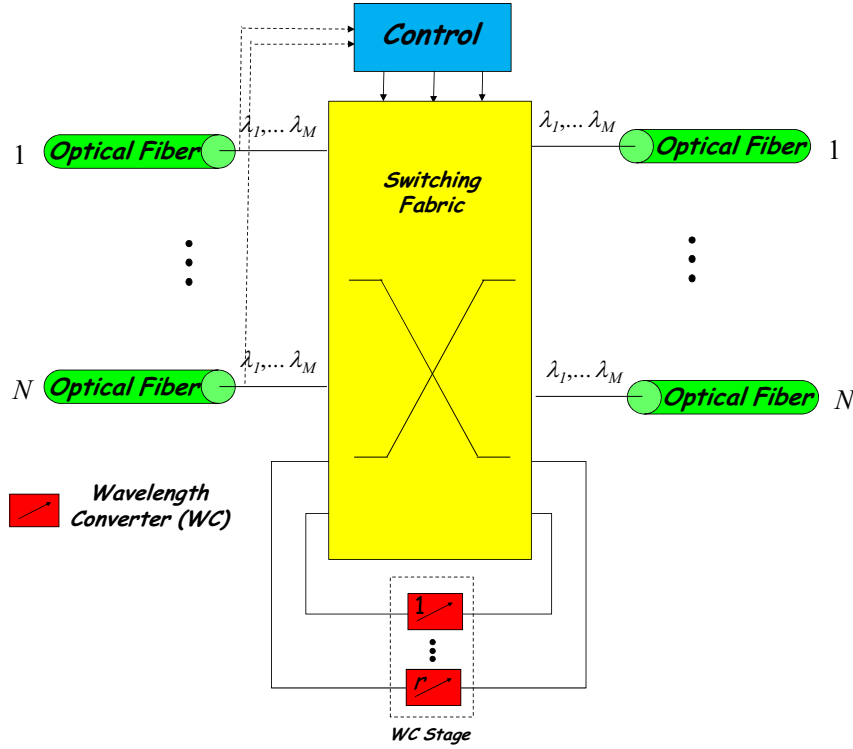

Fig. 1 Optical Packet Switching Architecture with N Input/Output Fibers, M Wavelength and r shared Wavelength Converters

the 1st stage. Each SSM is composed by one splitter and $N + r$ SOAs. The activated SOA allows the splitter loss to be overcome. One $NM \times 1$ SSM of the 2nd stage, composed by one coupler and one SOA, has the function to forward to the WC stage a packet to be wavelength converted. The SOA gain allows the coupler loss to be overcome. The converted packets are sent to the OFs by turning on one SOA of a $1 \times N$ SSM of the 3rd stage. Finally each OF is equipped with an $(NM + r) \times 1$ SSM in the 4th stage whose function is to address towards the OF the packets coming either from the Input Wavelength Channels or from the pool of shared WCs.

III. ANALYTICAL EVALUATION OF THE POWER CONSUMPTION IN SPANKE SWITCH

To evaluate the Spanke switch energy consumption we use the model illustrate in [9] to evaluate the SOA's power consumption C_{SOA} . According to this model, P_{SOA} can be expressed as follows:

$$C_{SOA} = V_b I_b = V_b \left(1 + \frac{\log_e G^{us}}{\Gamma_{SOA} \alpha_{SOA} L_{SOA}} \right) i_t \quad (1)$$

where V_b is the SOA forward bias voltage, I_b is the polarization current, Γ_{SOA} is the confinement factor, α_{SOA} is the material loss, L_{SOA} is the length and i_t is the transparency current given by:

$$i_t = \frac{q w_{SOA} d_{SOA} L_{SOA} N_0}{\tau} \quad (2)$$

w_{SOA} being the SOA active region effective width, d_{SOA} the active region depth, $q = 1,6 \times 10^{-19} C$ the electronic charge, N_0

the conduction band carrier density required for transparency, τ the carrier spontaneous decay lifetime. The amount of gain saturation G^s is a function of the SOA input power P_{SOA}^{in} and the following nonlinear equation gives the unsaturated gain G^{us} required to produce saturated gain G^s [10]:

$$G^{us} = G^s \exp \left((G^s - 1) \frac{P_{SOA}^{in}}{P_{sat}} \right) \quad (3)$$

In evaluating the various power consumption in the Spanke switch shown in Fig. 2 we notice that at time t :

- there are as many turned on SOAs in 1st stage as the number $N_a(t)$ of packets forwarded;
- the number of turned on SOAs in both 2nd stage and 3rd stage equals the number $N_c(t)$ of converted packets;
- there are as many active turned on SOAs in 4th SSM stage as the number $N_d(t)$ of OFs in which at least one packet is directed;
- we assume that all of the r Wavelength Converters are turned on.

According to these remarks we can write the following expression for the average power consumption $P_{av,T}^{Spanke}$ for the Spanke switch shown in Fig. 2:

$$P_{av,T}^{Spanke} = E[N_a] C_1^{SOA} + E[N_c] (C_2^{SOA} + C_3^{SOA}) + E[N_d] C_4^{SOA} + r C_{WC} + E[N_{SOA}^{MVMC,off}] C_{off}^{SOA} \quad (4)$$

wherein:

- C_i^{SOA} ($i=1, \dots, 4$) is the power consumption of a turned on SOA in the i th stage ($i=1, \dots, 4$);

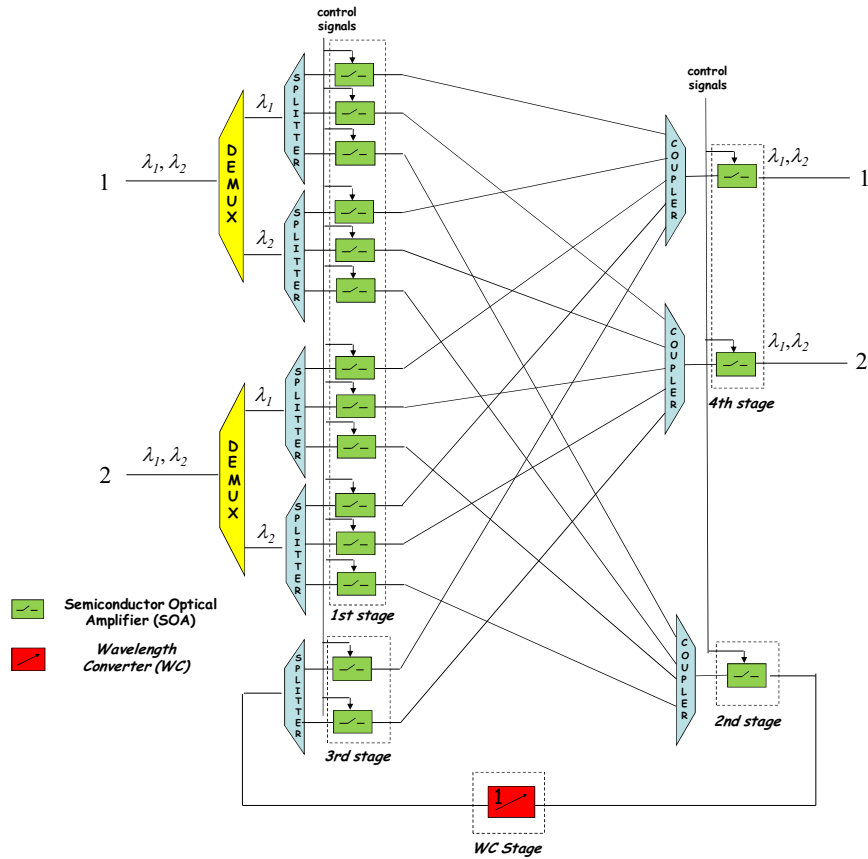
 Fig. 2 Spanke Optical Packet Switch ($N=2, M=2, r=1$)

- C_{WC} is the power consumption of a Wavelength Converter;
- C_{off}^{SOA} is the power consumption of a turned off SOA; it is equal to $V_b i_{off}$ where i_{off} is the polarization current of an inactive SOA and needed to guarantee a high SOA switching rate [11];
- $E[N_a]$, $E[N_d]$ and $E[N_c]$ are the steady-state average values of the random processes $N_a(t)$, $N_d(t)$ and $N_c(t)$ respectively at an arbitrary epoch; the evaluation of $E[N_a]$, $E[N_d]$ and $E[N_c]$ is carried out in [12];
- $E[N_{SOA}^{Spanke,off}]$ is the number of turned off SOAs; it is given by the total number $N_{SOA}^{Spanke,tot} = N(N+r)M + r + Nr + N$ of SOAs in the MVMD switch to the total number $N_{SOA}^{Spanke,on} = E[N_a] + 2E[N_c] + E[N_d]$ of turned on SOAs that is:

$$E[N_{SOA}^{Spanke,off}] = N(N+r)M + r + Nr + N - (E[N_a] + 2E[N_c] + E[N_d]) \quad (5)$$

To evaluate C_i^{SOA} ($i=1, \dots, 4$) we notice that an accepted packet may follow either of the paths reported in Fig. 3.a and Fig. 3.b according to the case in which it is or not wavelength converted. In the Figures we report both the values of loss introduced by the splitters and couplers and the SOA saturated gain. From Fig. 3.b and by using the expression of the power consumption of a cascade of SOA and passive elements reported in [13]-[14], the expressions Eqs (6)-(8)

reported at page 3 can be obtained for C_i^{SOA} ($i=1, 2, 3$), wherein:

- P_s^{in} is the input signal power;
- P_{ASE}^{in} is the Amplifier Spontaneous Emission (ASE) noise power;
- $P_{se} = n_{sp} p_{eff} h \nu_c B_0$; each SOA is assumed to emit ASE with constant spectral density within the optical bandwidth B_0 ; ν_c is the center frequency, h is the Planck constant, n_{sp} is the excess spontaneous emission factor [15], p_{eff} is a factor which ranges from 1 for a device which amplifies only one polarization to 2 for a polarization-insensitive device.

The evaluation of the power consumption C_4^{SOA} is evaluated in [14] and it is reported in Eq. (9) at page 4. Finally notice as by inserting Eqs (5)-(9) in Eq. (4) and by using the expressions of $E[N_a]$, $E[N_d]$ and $E[N_c]$ evaluated in [12], we are able to calculate the average power consumption $P_{av,T}^{Spanke}$ of the Spanke switch.

IV. NUMERICAL RESULTS

Next we use the analytical model introduced in Section III to evaluate the average energy consumption per bit $E_{av,T}^{Spanke} = \frac{P_{av,T}^{Spanke}}{NMB}$ in Spanke switch, where N is the number of Input/Output Fibers, M is the number of wavelengths and B denotes the bit rate carried out on each wavelength. We will

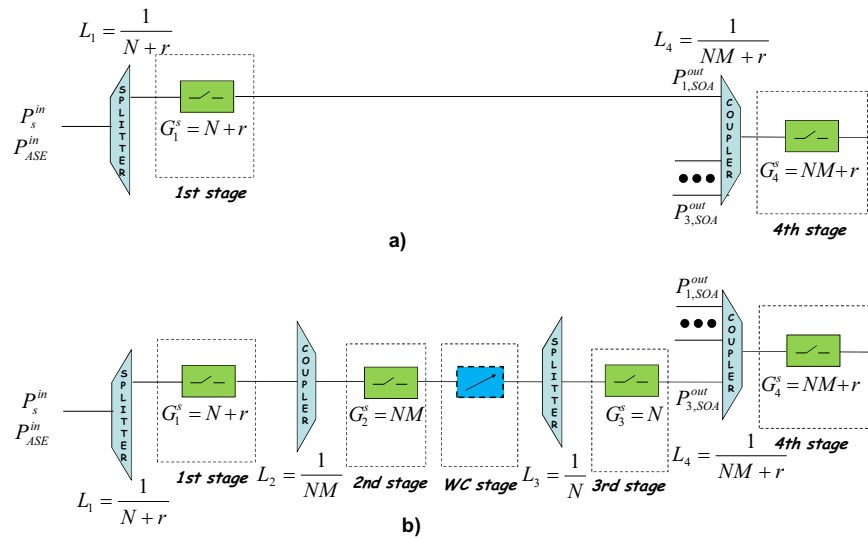

Fig. 3 Paths followed in the Spanke switch by a packet in the cases in which it is directly forwarded (a) or it is wavelength converted (b). For each path the attenuation and the gain of the splitters, couplers and SOAs are reported

$$C_1^{SOA} = V_b \left(1 + \frac{\log_e(N+r) + \frac{(N+r-1)(P_s^{in} + P_{ASE}^{in})}{(N+r)P_{sat}}}{\Gamma_{SOA} \alpha_{SOA} L_{SOA}} \right) i_t \quad (6)$$

$$C_2^{SOA} = V_b \left(1 + \frac{\log_e(NM) + \frac{(NM-1)(P_s^{in} + P_{ASE}^{in} + P_{se}(N+r-1))}{NM P_{sat}}}{\Gamma_{SOA} \alpha_{SOA} L_{SOA}} \right) i_t \quad (7)$$

$$C_3^{SOA} = V_b \left(1 + \frac{\log_e N + \frac{(N-1)(P_s^{in} + P_{ASE}^{in} + P_{se}(N+r-1) + P_{se}(NM-1))}{N P_{sat}}}{\Gamma_{SOA} \alpha_{SOA} L_{SOA}} \right) i_t \quad (8)$$

show how the ASE noise generated at the switch input may influence the power consumption of the Spanke switch due to SOA gain saturation. We perform the analysis under the following assumptions:

- The SOA's power consumption model illustrated in [9] is adopted and allowing us, according to Eq. (1), to express the SOA power consumption as a function of the main SOA parameters (V_b , i_b , w_{SOA} , ...); A#1 commercial SOAs [12] produced by manufacture A is used to implement the switching fabric. The A#1 parameter values are reported in Table I.
- As Wavelength Converter, the Delayed Interference Signal Wavelength Converter (DISC) proposed in [16] is used. DISC utilizes an SOA and an Optical Bandpass Filter placed at the amplifier output. It can be constructed by using commercially available fiber-pigtailed components. It has a simple configuration and allows photonic integration. Its power consumption has been evaluated in [16] when commercial SOA produced by some manufactures are employed. In particular we consider the A#2 SOA characterized by a Multiple Quantum Well (MQW) type structure and produced by manufacture A. We report in

TABLE I
MAIN PARAMETER VALUES FOR THE A#1 COMMERCIAL SOAs

Symbol	Explanation	Value
V_b	Forward Bias Voltage	2 V
Γ_{SOA}	Confinement Factor	0.15
α_{SOA}	Material Loss	10^4
L_{SOA}	Length	$700 \mu m$
w_{SOA}	Active Region Effective Width	$2 \mu m$
d_{SOA}	Active Region Depth	$0.1 \mu m$
N_0	Conduction Band Carrier Density	$10^{24} m^{-3}$
τ	Carrier Spontaneous Decay Lifetime	$10^{-9} s$
P_{sat}	Saturation Power	50 mW

Table II the main parameter values for A#2. The power consumption, measured in [16], is also reported. It equals 187mW when the WC is operating at bit-rate $B=40$ Gb/s.

- We assume that the ASE noise P_{ASE}^{in} is generated by a Wavelength-Division Multiplexing (WDM) transmission system comprising S identical stages, each of length (i.e., EDFA amplifier spacing) L as illustrated in Fig. 4. The total length of the transmission system is $L_{tot} = SL$. Each stage in Fig. 4 is modeled by a fiber attenuation

$$C_4^{SOA} = V_b \left(1 + \frac{\ln(NM+r) + \frac{(NM+r-1)(E[N_a](P_s^{in} + P_{ASE}^{in} + P_{se}(N+r-1)) + E[N_c](P_{se}(NM-1) + P_{se}(N-1)))}{N(NM+r)P_{sat}}}{\Gamma_{SOA}\alpha_{SOA}L_{SOA}} \right) i_t \quad (9)$$

TABLE II

MAIN PARAMETER VALUES FOR THE A#2 COMMERCIAL SOA; THE POWER CONSUMPTION OF DISCS REALIZED WITH A#2 SOAs IS ALSO REPORTED AT BIT-RATE $B=40$ GB/s

B#I	Type	Active region Length (μm)	Active region width (μm)	Active region thickness (μm)	Confinement Factor	Consumed power (mW) (40Gb/s)
	MQW	1100	1,25	0,038	0,2	187

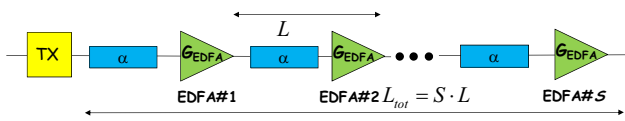

Fig. 4 Schematic of optically amplified link, comprising an optical transmitter, S identical stages of optical gain. Each stage has length L and the used fiber is characterized by an attenuation equal to α dB/Km. L_{tot} is the total length of the optically amplified link

block with a power loss of $D_{fiber} = e^{-\alpha L}$, where α is the power attenuation per unit length of the fiber and an amplifier gain block with power gain G_{EDFA} which is equal to the loss per stage (i.e., $G_{EDFA} = D_{fiber}$). At each wavelength, the ASE noise P_{ASE}^{in} is given by the following expression [17]:

$$P_{ASE}^{in} = 2n_{sp}^{EDFA} S(e^{\alpha L} - 1)h\nu_c B_0 \quad (10)$$

where n_{sp}^{EDFA} is the excess spontaneous emission factor of each EDFA amplifier.

We choose the switch parameters $N=32$, $M=64$ and the offered traffic $p=0,8$. The operation bit-rate is $B=40$ Gb/s and the optical bandwidth is $B_0=100$ GHz. The used SOAs are characterized by the parameters $n_{sp}=3,5$, $p_{sp}=2$. Power consumption is not taken into account for the turned off SOAs ($i_{off}=0$). The energy consumptions are reported in Fig. 5 varying the number S of stages from 0 to 30 of the transmission system generating ASE noise at the switch input. Each stage has length $L=60$ Km with attenuation $\alpha = 0,2$ dB/Km and each EDFA is characterized by $n_{sp}^{EDFA}=1$. The case $S=0$ corresponds to the case in which no ASE noise is generated because electrical regeneration is performed before the switching operation. We also report in Fig. 6 the SOA power consumption and versus the number r of WCs for $S=0$ and $S=20$. From Fig. 5 we can notice how the increase in ASE noise makes less energy efficient the Spanke switch. For instance in the case of Spanke switch and when $r=320$ WCs are used, $E_{av,T}^{Spanke}$ increases from $3,85 \cdot 10^{-2}$ nJ/bit to $5,02 \cdot 10^{-1}$ nJ/bit when S increases from 0 to 30. That is consequence of the increase in ASE noise that saturates the SOAs gain leading to the need to increase the power consumption as indicated by the Eqs (5)-(9).

The increase in power consumption due to the ASE noise is confirmed in Fig. 7 where we report the average energy

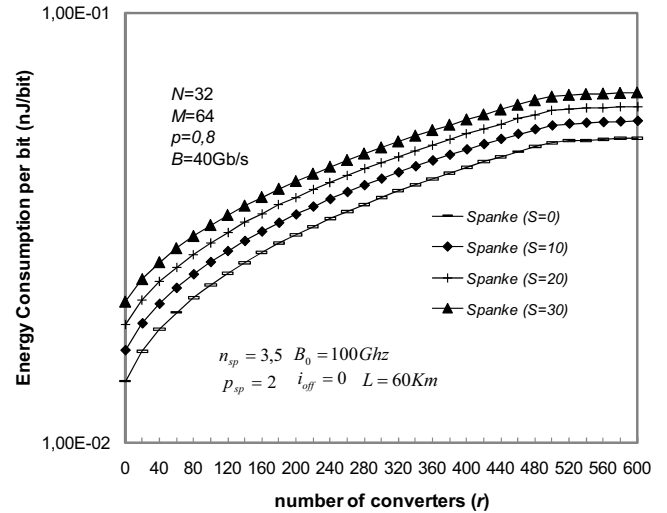

Fig. 5 Average energy consumption per bit $E_{av,T}^{Spanke}$ in Spanke switch versus the number r of used WCs. The switch parameters are $N=32$, $M=64$ and the offered traffic is $p=0,8$. The bit-rate carried on each input wavelength channel is $B=40$ Gb/s. The optical bandwidth is $B_0=100$ GHz and the used SOAs are characterized by $n_{sp}=3,5$, $p_{sp}=2$ and $i_{off}=0$. The ASE noise at the switch input is generated by a transmission system characterized by $L=60$ Km, $\alpha=0,2$ dB/Km and S varying from 0 to 30

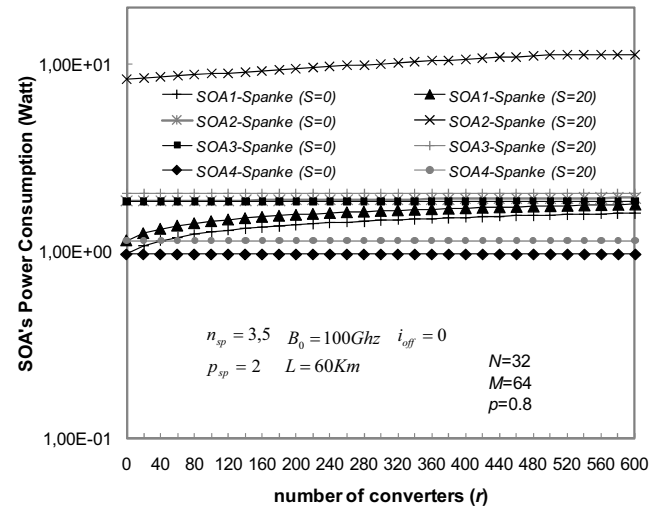

Fig. 6 SOA Power Consumption in Spanke switch versus the number r of used WCs. The same parameters of Fig. 5 are used

consumption per bit $E_{av,T}^{Spanke}$ in Spanke switch as a function of the offered traffic p and for $N=32$, $M=64$, $B=40$ Gb/s, $B_0=100$ GHz, $n_{sp}=3,5$, $p_{sp}=2$ and $i_{off}=0$. A transmission system with $L=70$ Km and S varying from 0 to 30 is considered. The pool of WCs in Spanke switch is optimally dimensioned with the minimum number r_{th} of WCs needed to reach the saturation packet loss probability due to the lack of output

wavelength channels [18].

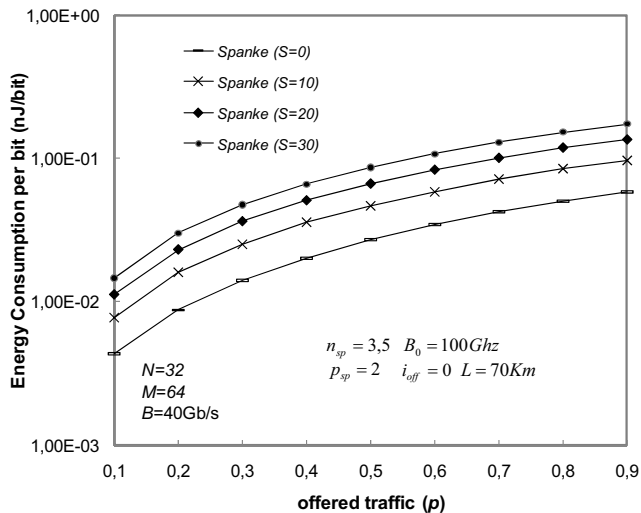

Fig. 7 Average energy consumption per bit $E_{av,T}^{Spanke}$ in Spanke switch versus the offered traffic p for $N=32$, $M=64$. The bit-rate carried on each input wavelength channel is $B=40$ Gb/s. The optical bandwidth is $B_0=100$ GHz and the used SOAs are characterized by $n_{sp}=3,5$, $p_{sp}=2$ and $i_{off}=0$. The ASE noise at the switch input is generated by a transmission system characterized by $L=70$ Km, $\alpha=0,2$ dB/Km and S varying from 0 to 30

V. CONCLUSION

We have proposed a sophisticated analytical model in order to evaluate the average energy consumption per bit of the Spanke switch. In the evaluation of the energy consumption we take into account the ASE noise generated by the transmission system that can degrade the performance in power consumption because of the gain saturation of the SOA gates needed to realize the switching fabric. We have verified the the ASE noise generated by a transmission system may strongly degrade the switch performance in terms of power consumption. As a matter of example, if a switch with $N=32$ and $M=64$ is taken into account and the offered traffic p equals 0,8, the average energy consumption per bit is $1,53 \cdot 10^{-1}$ nJ/bit in the case of a transmission system of total length 2100Km and $S=30$ spans.

ACKNOWLEDGMENT

The research leading to these results has received funding from the European Community's Seventh Framework Programme FP7/2007-2013 under grant agreements n 247674 (STRONGEST-Scalable, Tuneable and Resilient Optical Networks Guaranteeing Extremely-high Speed Transport).

REFERENCES

- [1] C. Bianco, F. Cucchiatti, G. Griffa, *Energy consumption trends in the next generation access network a telco perspective*, Proc. 29th Internat. Telecommunications Energy Conf. (INTELEC 2007), Rome, Italy, September 2007, pp.737-742.
- [2] Telecom Italia, *The Environment*, available at <http://www.telecomitalia.it/sostenibilita2006/English/B05.html>.
- [3] BT Press, *BT announces major wind power plans*, available at <http://www.btplc.com/News/Articles/Showarticle.cfm?ArticleID=dd615e9c-71ad-4daa-951a-55651baae5bb>, October 2007.
- [4] J. Chabarek, J. Sommers, P. Barford, C. Estan, D. Tsang, S. Wright, *Power Awareness in Network Design and Routing*, IEEE INFOCOM 2008, Phoenix, Arizona, April 2008.
- [5] D. Blumenthal, P. Prucnal, J. Sauer, *Photonic Packet Switches: Architectures and Experimental Implementations*, Proceeding IEEE, vol. 82, pp. 84-94, February 2000.
- [6] D. Chiaroni, *Packet Switching Matrix: A Key Element for the Backbone and the Metro*, IEEE Journal Selected Area Communications, vol. 21, pp. 1018-1025, September 2003.
- [7] S. Aleksic, *Analysis of Power in Future High Capacity Network Nodes*, IEEE/OSA Journal of Communications and Networking, vol. 1, pp. 245-258, August 2009.
- [8] V. Eramo, M. Listanti, *Power Consumption in Bufferless Optical Packet Switches in SOA Technology*, IEEE/OSA Journal of Communications and Networking, vol. 1, August 2009.
- [9] K. Hinton, G. Rakutti, P. Farrel, R.S. Tucker, *Switching Energy and Device Size Limits on Digital Photonic Signal Processing Technologies*, IEEE Journal of Selected Topics in Quantum Electronics, vol. 14, pp. 938-945, May/June 2008.
- [10] G. Jeong, J.W. Goodman, *Gain Optimization in Switches Based on Semiconductor Optical Amplifiers*, IEEE/OSA Journal Lightwave of Technology, vol. 13, pp. 598-605, April 1995.
- [11] A. Ehrhardt, M. Eiselt, G. Groβkopf, L. Kuller, R. Ludwig, W. Pieper, R. Schnabel and H. Weber, *Semiconductor Laser Amplifier as Optical Switching Gate*, IEEE/OSA Journal Lightwave of Technology, vol. 11, pp. 1287-1295, August 1993.
- [12] V. Eramo, *Comparison in Power Consumption of Synchronous and Asynchronous Optical Packet Switches*, IEEE/OSA Journal Lightwave of Technology, vol. 28, pp. 847-857, March 2010.
- [13] R.F. Kalman, L.G. Kazovsky, J.W. Goodman, *Space Division Switches Based on Semiconductor Optical Amplifiers*, IEEE Photonic Technology Letters, vol. 4, pp. 1048-1051, September 1992
- [14] V. Eramo, *Effect of ASE noise on the Power Consumption of MVMC and BENES Optical Packet Switches*, IEEE/OSA Journal of Communications and Networking, submitted to publication.
- [15] C.H. Henry, *Theory of Spontaneous Emission Noise in Open Resonators and its Applications to Laser and Optical Amplifier*, IEEE/OSA Journal Lightwave of Technology, vol. 4, pp. 288-297, April 1986.
- [16] Y. Ueno, J. Sakaguchi, R. Nakamoto, T. Nishida, *Ultrafast, low-energy-consumption, semiconductor-based, all-optical devices*, 4-th Asia-Pacific Photonics Conference (APMP 2009), Beijing, China, April 2009.
- [17] R.S. Tucker, *Green Optical Communications-Part I: Energy Limitations in Transport*, IEEE Journal of Selected Topics in Quantum Electronics, March/April 2011.
- [18] V. Eramo, M. Listanti, C. Nuzman, P. Whiting, *Optical Switch Dimensioning and the Classical Occupancy Problem*, International Journal Communications Systems, vol. 15, pp. 127-141, March/April 2002.